



Dräger - your marine safety specialist

Firefighting monitor catalogue
Monitor nozzles and foam applicators

Dräger Nederland B.V.
Marine & Offshore

Tel.: +31 (0)10 - 295 2740

Fax: +31 (0)10 - 295 2709

sales-mo.sd.nl@draeger.com

www.draeger-mo.com

© Copyright Dräger Nederland B.V.

All rights reserved. Reproduction in whole or part without prior written permission from Dräger is prohibited. Great care has been taken throughout the catalogue to be accurate, but Dräger cannot accept any responsibility for any errors or omissions which might occur.

All products, logos, names and technologies are trademarks and/or registered trademarks of their respective companies.

2016

Safety on board

As a Total Care Service organization Dräger would like to team up with your company as the service company for the annual service and maintenance for the following Fire fighting, Rescue & Safety (FRS) equipment.

Our scope of service capabilities includes (but is not limited to):

- portable and wheeled fire extinguishers
- fixed fire suppression systems and foam systems
- fire hoses and spray nozzles
- survival suits and lifejackets
- portable and fixed gas detection
- breathing protection and breathing compressors and fireman's outfits

ONE PARTNER FOR ALL FRS SOLUTIONS

Dräger has readily available resources to send qualified service teams and offshore containers offshore which have the skills to perform the required service on the above equipment in one visit.

This not only reduces overhead in organizing service and travelling of technicians but also gives you one point of contact for all maintenance, certification and related administration.

SAFETY MANAGEMENT SYSTEM

Our technicians all have offshore experience, and are trained to the required standards. Dräger is in possession of a ISO9001 certificate, has a Safety Management System in place and is an approved service organization for major class societies.

DEDICATED TO THE OFFSHORE WORLD

Years of experience and highly trained and certified technicians make Dräger an authority on fire fighting, rescue and safety projects for the marine and offshore industries. Our organization has a strong global presence and meets all of the requirements of high safety and quality standards.

Dräger Marine & Offshore is located in Rotterdam, Aberdeen and Stavanger. Dräger is available 24 hours a day, seven days a week and 365 days a year.

Meeting our customers needs is the cornerstone of our organization. We clearly understand that long-lasting relationships are built upon mutual trust and proven reliability.

DRÄGER INTERNATIONAL

Dräger was founded in 1889 in Lübeck, Germany. Dräger is one of the world's leading suppliers of personal protective equipment, gas detection technology, and interdisciplinary system solutions for total hazard management. The company, with more than 13,500 employees, has global sales of over 500 million euros.

Dräger. Technology for life.

Advanced service system

MONITORING MAINTENANCE

Dräger uses advanced ERP planning and registration software by Microsoft Navision®, which offers:

- Barcode marking of all equipment
- Equipment will be integrated into our ERP system
- ERP system equipped with service planning software
- One click overview of service to be performed per rig, per year
- Annual budget forecasting for up to five years

ADVANTAGES

- Every service action can be planned
- One overview of all equipment on board of all rigs
- One overview of service performed on a unit basis
- Certificates produced straight from the system

Every single item is registered:

- Barcode
- Serial number
- Type of equipment
- Manufacturer
- Lifetime of equipment
- Service actions required
- Special surveys

MOBILE WORKSHOP ON BOARD

Dräger has DNV approved offshore service containers, fully equipped with test equipment, spare parts and replacements, to perform FRS service on board of a platform.

The containers have been equipped with a computerized Dräger SCBA test bench and other test equipment. Service of fire fighting, life saving appliances such as life jackets and survival suits, portable and fixed gas detection equipment, hospital oxygen systems etc can all be performed on board.

Alongside the test equipment these containers have enough spare parts and new equipment to be able to carry out repairs and/or replace defective equipment as required.

FRS CERTIFICATE PORTAL

Dräger offers you the FRS Certificate Portal:

- Review, print, download and e-mail certificates in a digital online environment
- 24/7 availability, all you need is an Internet connection
- All certificates are clearly organized per order
- Only one login code needed for complete overview of all installations / locations / vessels
- This service is free of charge
- Registration via www.draeger-mo.com

This service is meant for everybody who manages FRS certificates on board of your rig.

Total Care FRS service contract concepts

In some cases it can be desirable to use service contracts to have a stable overview of what can be expected from service costs in the future. Dräger has developed two concepts offering a variable degree of certainty about future maintenance (and replacement) costs. We are able to offer contracts where the variables of service cost and replacements can be contractually bound. The contracts are developed to offer two degrees of certainty and are named as described in the following paragraph.

DRÄGER OFFSHORE SERVICE CONCEPTS

Dräger offers two service contract solutions to accommodate different customer requirements:

- Dräger Premium
- Dräger Life Cycle Management

These concepts form the basis for installment of service contracts, offering multiple levels of security on future FRS service spending.

DRÄGER PREMIUM

An Dräger Premium contract takes away uncertainty about current and future service costs and requires less administrative involvement of the customer.

Dräger-Premium covers all annual service needs:

- Deployment of offshore container to rig location
- Deployment of Dräger service technicians
- Includes all agreed FRS service activities
- Possibility to include discount on product groups and parts
- One-stop onboard service and maintenance of all FRS equipment
- Fully equipped offshore container, including all service equipment
- Small stock of new replacements present in container
- Spare parts and replacements are not included

DRÄGER PREMIUM ADVANTAGES

- One annual visit to service all FRS equipment
- Includes all mandatory service actions for the included equipment
- No backflow of service intervals
- One PO and one invoice per rig / per year
- Less administrative involvement of customer

DRÄGER LIFE CYCLE MANAGEMENT

The most advanced service contract is the Dräger Life Cycle Management contract.

Dräger LCM covers your concerns about FRS service and replacement to one service provider:

Dräger-Premium package plus:

- Replacement of the equipment at the end of the life cycle (excluding replacement of fixed equipment: hydrants, CO2 installations, etc.)
- Replacements of spare parts
- Standardization of equipment by replacement with latest standards and approvals
- Exchange equipment when necessary
- Requires preparation to implement
- An exact FRS inventory list per rig is required
- Easy to maintain / extent / decrease

DRÄGER LIFE CYCLE MANAGEMENT ADVANTAGES

- Only one visit to the rig
- Less involvement of crew in the service activities
- No additional spare part costs
- The equipment is up to date and in optimal condition
- Equipment to the latest technical/approval standards
- Crew members are more easily redistributed between rigs (because of standardization of equipment)

Rental equipment and training

RENTAL EQUIPMENT

Via a rental pool Dräger makes all the safety-relevant equipment required (during shutdown) available to you, from communications technology or gas detection devices to personal protection equipment.

Renting devices – with predictable rental rates – is the ideal solution for clearly defined projects. If necessary, we provide you with detailed advice which devices you should keep available in which numbers.

You can trust our experience and expect realistic projections. 10 additional gas detection devices, 20 fall arrest belts and a ladder – not everything can be scheduled down to the day. No problem. We take care of it for you.

We record all material movements in our database. This documentation enables easy controlling and also forms the basis for traceable invoicing.

TRAINING

Complete safety does not end with the purchase of safety equipment – in fact it is only the beginning!

To be effective, operators need to be competent and empowered in the use, testing and troubleshooting of safety equipment. That's where effective training is an essential addition to a user's safety regime.

With over 100 years experience in safety, Dräger is able to bring a wealth of knowledge in the use of equipment and best practice procedures in response to hazardous situations.

With a comprehensive range of training programmes for the oil and gas industry we can help to ensure your equipment and personnel are always ready – whatever the situation. Courses can be customised to suit specific requirements, known hazards or unusual applications and conducted at operational sites.

If preferred, they can also be carried out at our purpose built training facilities using simulated environments including crawl galleries and confined spaces.

Courses cover both theory and hands on use of equipment in practical applications; testing; maintenance and troubleshooting - for everything from gas detection set up and calibration – both fixed and portable; breathing apparatus; drugs and alcohol detection and first aid.

Quality, safety and liability

QUALITY

We guarantee that the offered services are performed to the very highest standards. The quality of our work and our organization is safeguarded by a certified Quality Management System ISO 9001:2000, ISO14001 and OHSAS18001.

During a contract period Dräger always commits itself to keep the Quality Management System certified and valid. In addition, we welcome an audit by your quality manager at any time.

SAFETY

Safety on board is a key consideration for all professional operators. It is therefore reassuring that our service technicians are all in possession of a basic safety certificate. They understand the possible risks on board and they know what is expected from them to ensure the safety for themselves, your crew and your assets.

Our safety management system ensures that our procedures and our behavior are regularly monitored and adjusted where required. Of course it is possible to audit our safety system. Please ask your safety manager to contact us at any time to make an appointment.

LIABILITY INSURANCE

As part of the world wide operating Dräger group (www.draeger.com) our organization is in possession of a liability insurance which cover our activities. On request we can send you a copy of the insurance policy.

CUSTOMER SATISFACTION

We are your Fire fighting, Rescue and Safety partner who will provide solutions to meet your needs. We clearly understand that long-lasting relationships are built upon mutual trust and proven reliability. Therefor customer satisfaction is a key performance indicator for us.

We constantly monitor our customer satisfaction level and strive to improve our performance, our procedures and general behavior based on your feedback. We have a procedure in place which offers you the opportunity to share your suggestions and/or concerns.

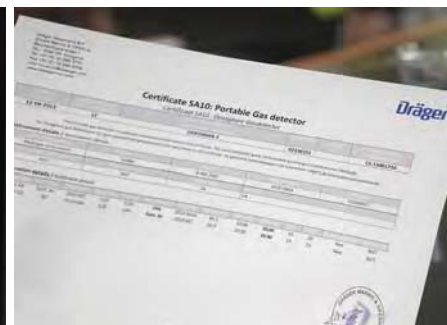
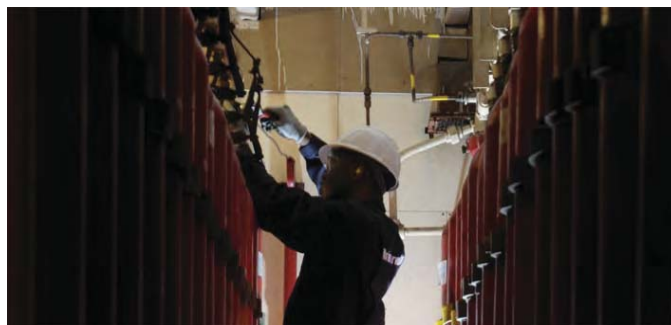

BOCCELLO GETTO PIENO/FRAZIONATO – BNM
JET/FOG NOZZLE – BNM



1300 – 4000 lpm



4500 – 6000 lpm



6500 – 8000 lpm

Descrizione



Il bocchello BNM è un dispositivo di regolazione e controllo di flusso che viene montato sui monitori antincendio per generare flussi d'acqua o acqua/schiuma a getto pieno oppure frazionato. Il bocchello può essere facilmente regolato da getto pieno a getto frazionato per mezzo di due leve di comando posizionate sul corpo esterno. Le impugnature sono specificatamente lavorate in modo da offrire una impugnatura antiscivolo e rimanere dunque manovrabili in ogni condizione. La rotazione del bocchello per mezzo delle impugnature agisce sullo scorrimento del corpo superiore su quello inferiore variando conseguentemente l'angolazione del canale di erogazione. In condizioni di pressione costante, la portata rimane costante ma la geometria del getto varia da getto pieno a getto frazionato. Il bocchello BNM è disponibile con quattro attacchi standard diversi: flangia quadra FQ 125, FQ 150, ANSI 150 o F.BSP per il collegamento a monitori da 2.½", 3" e 4". Nelle versioni 1300 e 2000 l/min il bocchello è disponibile anche nella versione Shut-off e cioè capace di chiudere completamente il flusso direttamente dal bocchello. Il bocchello è inoltre disponibile anche in versione con comando manuale remoto per mezzo di catena, per consentire il controllo del bocchello in caso di installazione su palo. In opzione è possibile installare nel bocchello un dispositivo AUTOFOG che obbliga il monitor a erogare sempre in modalità FOG fino a quando l'operatore interviene manualmente per settare il bocchello in modalità Getto Pieno. Il bocchello ritornerà automaticamente in modalità FOG quando verrà meno la pressione al monitor. Questo meccanismo è particolarmente utile quando si proteggono rischi dove i monitori sono attivati automaticamente ed il personale potrebbe trovarsi di fronte al getto del monitor durante la fase iniziale di evacuazione. Un tipico esempio è quello delle piattaforme di atterraggio degli elicotteri protette con monitori auto-oscillanti. I materiali di costruzione disponibili variano dalle leghe di bronzo all'acciaio Inox rendendo il bocchello versatile ed idoneo per l'impiego con acqua di mare o soluzioni schiumogene all'interno di ambienti industriali ad alta aggressività o in applicazioni offshore.

Description



The BNM nozzle is a flow pattern regulating device that is installed on firefighting monitors to project flows of water or water/foam in full jet or fog condition. The nozzle can be easily adjusted from full jet to fog stream acting on two lever located on the external nozzle body. The grip of the two levers is specifically designed in order to provide an anti-slip surface and therefore being maneuverable in any conditions. Acting on the two levers causes the nozzle to rotate with a consequent variation of the flow impingement angle. At constant pressure, the flow remains constant but the jet geometry varies from full jet to a fog stream. The BNM nozzle is available with four different connections: square flanged SF125, SF150, ANSI 150 or F.BSP for connection with monitors of 2.½", 3" and 4". For the two flow rates of 1300 and 2000 lpm the nozzle is available as shut-off, hence capable to isolate the flow directly at nozzle. The nozzle is also available with remote manual control with chains, in order to control the nozzle when installed on tower. As optional the nozzle can be provided with AUTOFOG mechanism that force the monitor to start operation in FOG position until the operator will set it manually to Full Jet. The nozzle will return automatically to FOG when pressure is relieved from the monitor. This mechanism can be useful when protecting risks where monitors are actuated automatically and in which personnel could be found on the water jet path during initial evacuation of the area. A typical example is that of Helidecks platforms protected with self-oscillating monitors. The material of construction available varies from bronze alloys to stainless steel making the nozzle suitable for being used with sea water or water foam solution within industrial harsh environments & offshore applications.

Caratteristiche tecniche

- Corpo bocchello a scelta tra:
 - Bronzo EN 1982 – CC491K
 - Acciaio inox AISI 316
- Parti interne AISI 316 e ottone
- Leve di comando ottone
- Attacco mediante:
 - FQ 125
 - FQ 150
 - 6" ANSI 150
 - F.BSP
- Esecuzione idonea ad installazione esterna in ambiente marino e funzionamento con acqua mare e soluzioni schiumogene
- Pressione di progetto 16 bar

Ciclo verniciatura standard SA:

- Pulizia manuale con solvente
- Primer epossidico 60 µm
- Intermedio poliuretano 30 µm
- Finitura poliuretano 30 µm
- Spessore totale film secco 120 µm +/-10%
- Colore rosso RAL 3000

Technical characteristics

- Body material to be selected among
 - Bronze EN 1982 – CC491K
 - Stainless Steel AISI 316
- Inner parts in stainless steel AISI 316 and brass
- Brass handgrip
- Connection:
 - SF 125
 - SF 150
 - 6" ANSI 150
 - F.BSP
- Suitable execution for external installation in marine environment and operation with sea water and foam solutions
- Design pressure: 16 bar

Painting system standard SA:

- Manual cleaning solvent
- Epoxy primer 60 µm
- Polyurethane intermediate 30 µm
- Polyurethane finish 30 µm
- Total thickness 120 µm dry film +/-10%
- Colour red RAL 3000

Dimensioni e Pesì

Dimensions and Weights

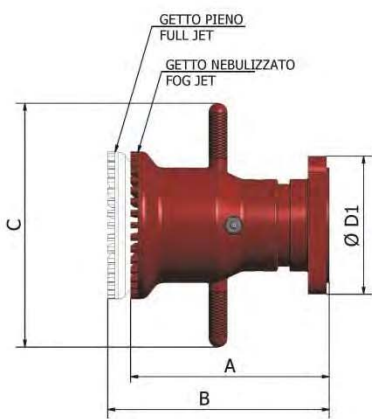

1300 - 4000 lpm

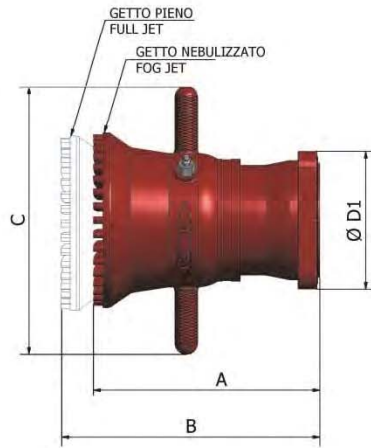

4500 - 6000 lpm

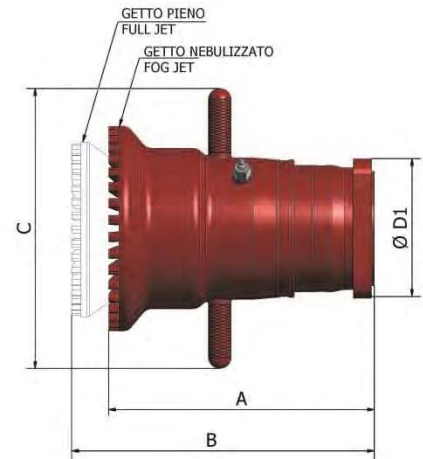

6500 - 8000 lpm

TYPE	Ø D1	A mm	B mm	C mm	Portata Massima (l/min a 7 bar) Max. Flow rate (lpm at 7 bar)														Peso Weight (kg)
					1300	1500	2000	2500	3000	4000	4500	5000	5500	6000	6500	7000	7500	8000	
1300 - 4000	F.BSP 2.1/2"	164	198	265	✓	✓	✓	✓	✓	✓	✗	✗	✗	✗	✗	✗	✗	✗	10,5
	FQ125 SF125	164	198	265	✓	✓	✓	✓	✓	✓	✗	✗	✗	✗	✗	✗	✗	✗	11
	FQ150 SF150	164	198	265	✓	✓	✓	✓	✓	✓	✗	✗	✗	✗	✗	✗	✗	✗	11,5
4500 - 6000	F.BSP 3"	265	296	295	✗	✗	✗	✗	✗	✗	✓	✓	✓	✓	✗	✗	✗	✗	25,5
	FQ150 SF150	265	296	295	✗	✗	✗	✗	✗	✗	✓	✓	✓	✓	✗	✗	✗	✗	26
6500 - 8000	F.BSP 4"	286	324	295	✗	✗	✗	✗	✗	✗	✗	✗	✗	✗	✓	✓	✓	✓	30
	FQ150 SF150	286	324	295	✗	✗	✗	✗	✗	✗	✗	✗	✗	✗	✓	✓	✓	✓	30,5
	ANSI 150 6"	286	324	295	✗	✗	✗	✗	✗	✗	✗	✗	✗	✗	✓	✓	✓	✓	31

Opzioni

- Ciclo di verniciatura diverso dallo Standard SA
- Dispositivo AUTOFOG
- Per ulteriori opzioni o versioni speciali contattare SA Fire Protection

Optional

- Painting system different from Standard SA
- AUTOFOG Mechanism
- For additional options or special versions contact SA Fire Protection

Codice Identificativo
Identification Form

OPZIONI / OPTIONS

Mod.

/ / / / /

1

2

3

4

5

6

Quantità / Quantity

BOCCHELLO GETTO PIENO/FRAZIONATO BNM / JET/FOG NOZZLE BNM

CORPO BODY		CONNESSIONE CONNECTION		PORTATA FLOW RATE	
1	Tipologia Type	Getto Pieno/Frazionato Jet/Fog	BNM <input type="checkbox"/>		
		Getto Pieno/Frazionato/Chiuso Jet/Fog/Shut-off	BNM TS <input type="checkbox"/>	Disponibile solo per portate 1300 e 2000 l/min. Available only for flow rate 1300 and 2000 lpm.	
		Getto Pieno/Frazionato con catene Jet/Fog with chains	BNMC <input type="checkbox"/>		
2	Materiale Material	Bronzo EN 1982 – CC491K Bronze EN 1982 – CC491K	CBG10 <input type="checkbox"/>		
		Acciaio inox AISI 316 Stainless steel AISI 316	CAI12 <input type="checkbox"/>		
3	Tipologia Type	FQ 125 SF 125	125 <input type="checkbox"/>	Disponibile solo per portate fino a 4000 l/min. Available only for flow rate up to 4000 lpm.	
		FQ 150 SF 150	150 <input type="checkbox"/>		
		6" ANSI 150	6 <input type="checkbox"/>	Disponibile solo per portate da 6500 a 8000 l/min. Available only for flow rate from 6500 to 8000 lpm.	
		F. BSP 2 1/2"	2M <input type="checkbox"/>	Disponibile solo per portate fino a 4000 l/min. Available only for flow rate up to 4000 lpm.	
		F. BSP 3"	3 <input type="checkbox"/>	Disponibile solo per portate da 4500 a 6000 l/min. Available only for flow rate from 4500 to 6000 lpm.	
		F. BSP 4"	4 <input type="checkbox"/>	Disponibile solo per portate da 6500 a 8000 l/min. Available only for flow rate from 6500 to 8000 lpm.	
4	Portata a 7 bar Flow rate at 7 bar	1300 l/min	13 <input type="checkbox"/>		
		1500 l/min	15 <input type="checkbox"/>		
		2000 l/min	20 <input type="checkbox"/>		
		2500 l/min	25 <input type="checkbox"/>		
		3000 l/min	30 <input type="checkbox"/>		
		4000 l/min	40 <input type="checkbox"/>		
		4500 l/min	45 <input type="checkbox"/>		
		5000 l/min	50 <input type="checkbox"/>		
		5500 l/min	55 <input type="checkbox"/>		
		6000 l/min	60 <input type="checkbox"/>		
		6500 l/min	65 <input type="checkbox"/>		
		7000 l/min	70 <input type="checkbox"/>		
		7500 l/min	75 <input type="checkbox"/>		
		8000 l/min	80 <input type="checkbox"/>		
Altro Other	F <input type="checkbox"/>	Specificare in Note la portata richiesta. Specify in Notes the flow rate required.			

OPZIONI OPTIONS	5	Dispositivo Mechanism	AUTOFOG	AF <input type="checkbox"/>	Disponibile solo per portate fino a 4000 l/min. Available only for flow rate up to 4000 lpm.
	6	Verniciatura Painting	Verniciatura diversa da ciclo SA standard Painting system different for SA standard	C <input type="checkbox"/>	Specificare in Note il ciclo di verniciatura richiesto. Specify in Notes the painting procedure required.
NOTE NOTES					
	CLIENTE / CLIENT:		PROGETTO / PROJECT:		DOC. No.:
EMESSO / ISSUED:		CONTROLLATO / CHECKED:		APPROVATO / APPROVED:	
DATA / DATE:		DATA / DATE:		DATA / DATE:	

**BOCCELLO CON PRESSIONE COSTANTE GETTO PIENO/FRAZIONATO – BPM
JET/FOG CONSTANT PRESSURE NOZZLE – BPM**



Descrizione



Il bocchello BPM è un dispositivo automatico che è capace di lavorare a pressione costante, variando il flusso in maniera da mantenere le caratteristiche ottimali del getto in tutte le condizioni. Il bocchello viene montato sui monitori antincendio per generare flussi d'acqua o acqua/schiuma a getto pieno oppure frazionato. La regolazione del getto è ottenuta tramite comando manuale agendo sullo scorrimento del corpo superiore su quello inferiore variando l'angolazione del canale di erogazione. Al variare della pressione all'ingresso del bocchello la portata varia fino a riportare la pressione al valore prestabilito. Il bocchello BPM è disponibile in Bronzo con due attacchi standard diversi: flangia quadra FQ 150 o ANSI 150 per il collegamento a monitori da 4" e 6". Il bocchello BPM è specificatamente progettato per raggiungere angolazioni di FOG fino a 120° capaci di generare dei muri d'acqua a nebulizzazione molto fine la cui dimensione è sufficientemente piccola per diluire efficacemente la nube tossica ma altrettanto pesante da consentire l'atterraggio della particella acido-legata al terreno. Queste caratteristiche sono particolarmente apprezzate dai progettisti di sistemi di contenimento gas solubili in acqua come l'acido fluoridrico, solventi polari o ammoniaca che impiegano il metodo della "wall mitigation strategy".

Description



The BPM is an automatic manually operated nozzle used as flow pattern regulating device on firefighting monitors and capable to project flows of water or water/foam in full jet or fog condition. The nozzle can be adjusted manually from full jet to fog stream acting on the nozzle and varying of the flow impingement angle. In response to pressure variation the BPM nozzle varies the flow rate in order to regulate the pressure to a given set point. The BPM nozzle is available in Bronze with two different connections: square flanged SF150 or ANSI 150 for connection with monitors of 4" and 6". The BPM nozzle has been specifically designed to achieve angles of FOG as wide as 120° capable to develop water walls with a very fine nebulization. The water particles so generated are small enough to dilute the gas vapor and heavy enough to precipitate the acid water droplets to the ground. These characteristics are very much appreciated when designing gas containment systems of water soluble chemicals such as Hydrogen Fluoride, Polar Solvents and Ammonia using the "wall mitigation strategy".

Caratteristiche tecniche

- Corpo bocchello in Bronzo EN 1982 – CC491K
- Leve di comando ottone
- Attacco mediante:
 - FQ 150
 - 6" ANSI 150
- Pressione costante 7 bar
- Portata variabile 1100 – 8000 L/min
- Esecuzione idonea ad installazione esterna in ambiente marino e funzionamento con acqua mare e soluzioni schiumogene
- Pressione di progetto 16 bar

Ciclo verniciatura standard SA:

- Pulizia manuale con solvente
- Primer epossidico 60 µm
- Intermedio poliuretano 30 µm
- Finitura poliuretano 30 µm
- Spessore totale film secco 120 µm +/-10%
- Colore rosso RAL 3000

Technical characteristics

- Body material in Bronze EN 1982 – CC491K
- Brass handgrip
- Connection:
 - SF 150
 - 6" ANSI 150
- Constant pressure 7 bar
- Variable flow rate 1100 – 8000 lpm
- Suitable execution for external installation in marine environment and operation with sea water and foam solutions
- Design pressure: 16 bar

Painting system standard SA:

- Manual cleaning solvent
- Epoxy primer 60 µm
- Polyurethane intermediate 30 µm
- Polyurethane finish 30 µm
- Total thickness 120 µm dry film +/-10%
- Colour red RAL 3000

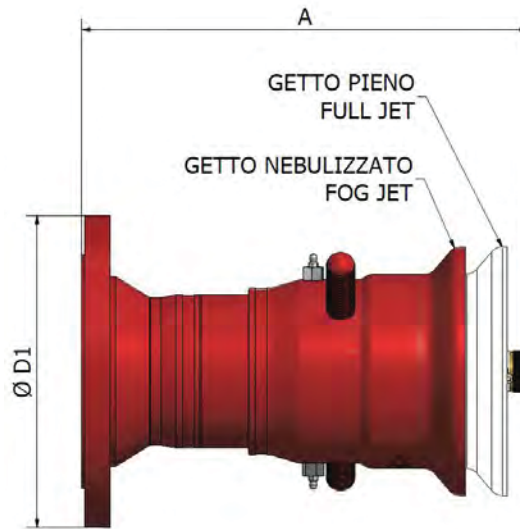

Ø D1	A mm	Peso Weight (kg)
FQ150 SF150	394	30,5
ANSI 150 6"	394	31

Opzioni

- Ciclo di verniciatura diverso dallo Standard SA
- Versione elettrica
- Versione oleo dinamico
- Per ulteriori opzioni o versioni speciali contattare SA Fire Protection

Optional

- Painting system different from Standard SA
- Electrical version
- Hydraulic version
- For additional options or special versions contact SA Fire Protection

Codice Identificativo
Identification Form

OPZIONI / OPTIONS

Mod.

BPM

80

1

2

3

4

5

6

7

Quantità / Quantity

BOCCELLO GETTO PIENO/FRAZIONATO BPM / JET/FOG NOZZLE BPM

CORPO BODY	1	Tipologia Type	Getto Pieno/Frazionato Jet/Fog	BPM <input checked="" type="checkbox"/>	
	2	Materiale Material	Bronzo EN 1982 – CC491K Bronze EN 1982 – CC491K	CBG10 <input type="checkbox"/>	
CONNESSIONE CONNECTION	3	Tipologia Type	FQ 150 SF 150	150 <input type="checkbox"/>	
			6" ANSI 150	6 <input type="checkbox"/>	
PORTATA FLOW RATE	4	Portata a 7 bar Flow rate at 7 bar	1100 – 8000 lpm	80 <input checked="" type="checkbox"/>	
OPZIONI OPTIONS	5	Verniciatura Painting	Verniciatura diversa da ciclo SA standard Painting system different for SA standard	C <input type="checkbox"/>	Specificare in Note il ciclo di verniciatura richiesto. Specify in Notes the painting procedure required.
	6	Tipologia Type	Versione elettrico Electrically version	EL <input type="checkbox"/>	Specificare in Note l'attuatore richiesto. Specify in Notes the actuator required.
	7	Tipologia Type	Versione oleo dinamico Hydraulic version	OH <input type="checkbox"/>	
NOTE NOTES					
CLIENTE / CLIENT:		PROGETTO / PROJECT:		DOC. No.:	REV.:
EMESSO / ISSUED:		CONTROLLATO / CHECKED:		APPROVATO / APPROVED:	
DATA / DATE:		DATA / DATE:		DATA / DATE:	

Diagrammi Prestazioni

Performance Diagrams

Pressione (bar) / Portata (L/min)
Pressure (bar) / Flow Rate (lpm)

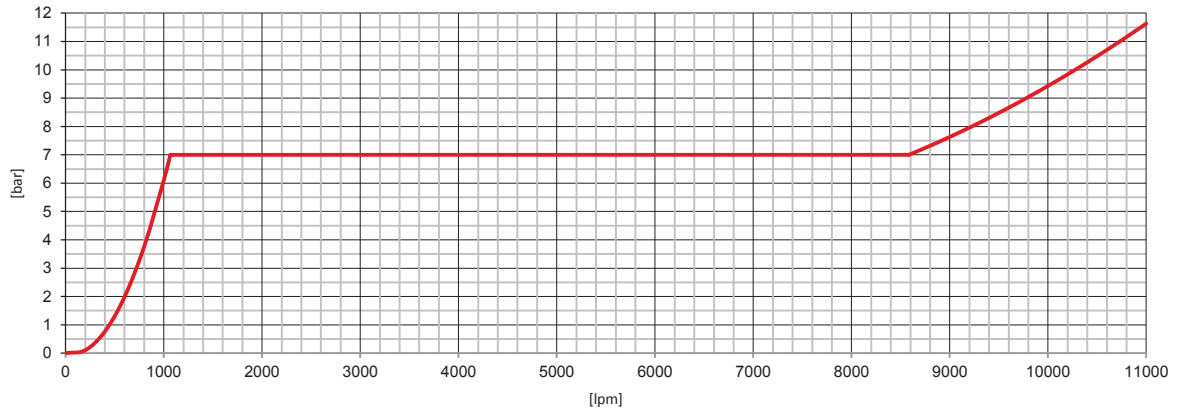

GETTO PIENO / FULL JET

Portata (L/min) / Gittata (m), angolo 30°
Flow Rate (lpm) / Throw (m), angle 30°

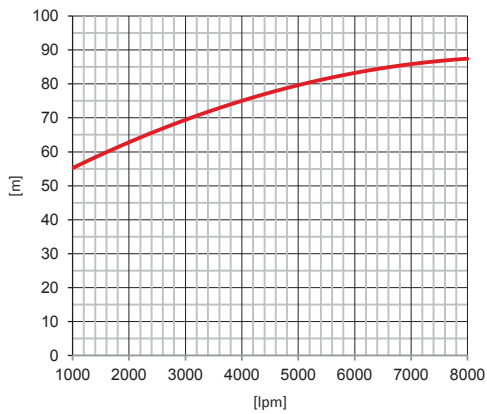

Portata (L/min) / Forza di reazione (kg)
Flow Rate (lpm) / Reaction Force (kg)

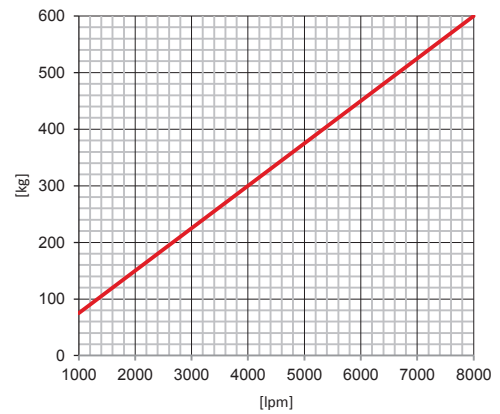

GETTO PIENO / FULL JET PORTATA / FLOW RATE 8000 lpm

Traiettorie (m), angoli 30° e 75° @ 7 bar
Trajectories (m), angles 30° and 75° @ 7 bar

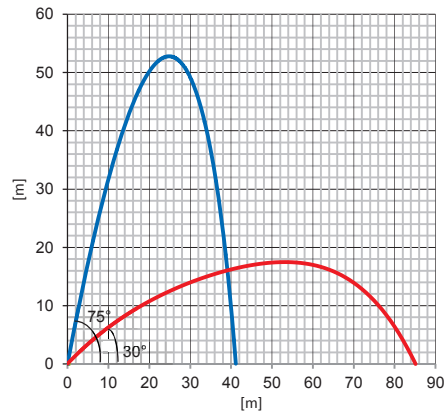

GETTO FRAZIONATO / FOG 30° PORTATA / FLOW RATE 8000 lpm

Traiettorie (m), angoli 30° e 75° @ 7 bar
Trajectories (m), angles 30° and 75° @ 7 bar

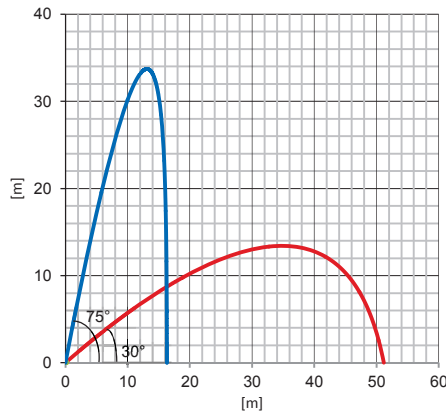

GETTO FRAZIONATO / FOG 60° PORTATA / FLOW RATE 8000 lpm

Traiettorie (m), angoli 30° e 75° @ 7 bar
Trajectories (m), angles 30° and 75° @ 7 bar

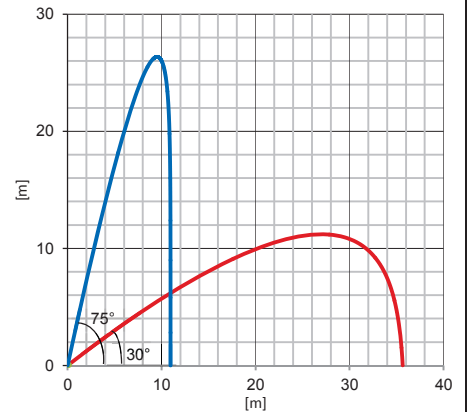

BOCCELLO OLEODINAMICO – BNO
HYDRAULIC NOZZLE – BNO



1300 – 4000 lpm



4500 – 6000 lpm



6500 – 8000 lpm

Descrizione



Il bocchello BNO è un dispositivo di regolazione e controllo di flusso a comando manuale ed idraulico che viene montato sui monitori antincendio per generare flussi d'acqua o acqua/schiuma a getto pieno oppure frazionato. Il bocchello può essere regolato da getto pieno a getto frazionato per mezzo di un attuatore idraulico a pistone posto sul corpo esterno. L'attuatore agisce sullo scorrimento del corpo superiore su quello inferiore variando l'angolazione del canale di erogazione. In condizioni di pressione costante, la portata rimane costante ma la geometria del getto varia da getto pieno a getto frazionato. Il bocchello BNO è disponibile con quattro attacchi standard diversi: flangia quadra FQ 125, FQ 150, ANSI 150 o F.BSP per il collegamento a monitori da 2 ½", 3" e 4". Il bocchello BNO è progettato per l'installazione con monitori idraulici o elettro-idraulici. I materiali di costruzione disponibili variano dalle leghe di bronzo all'acciaio Inox rendendo il bocchello versatile ed idoneo per l'impiego con acqua di mare o soluzioni schiumogene all'interno di ambienti industriali ad alta aggressività o in applicazioni offshore.

Description



The BNO an hydraulic operated nozzle used as flow pattern regulating device on firefighting monitors and capable to project flows of water or water/foam in full jet or fog condition. The nozzle can be adjusted from full jet to fog stream via an hydraulic actuator located on the external nozzle body. The electric actuator causes the nozzle to shift with a consequent variation of the flow impingement angle. At constant pressure, the flow remains constant but the jet geometry varies from full jet to a fog stream. The BNO nozzle is available with four different connections: square flanged SF125, SF150, ANSI 150 or F.BSP for connection with monitors of 2 ½", 3" and 4". The BNO nozzle is designed for installation with hydraulic and electro-hydraulic monitors. The material of construction available varies from bronze alloys to stainless steel making the nozzle suitable for being used with sea water or water foam solution within industrial harsh environments & offshore applications.

Caratteristiche tecniche

- Corpo bocchello a scelta tra:
 - Bronzo EN 1982 – CC491K
 - Acciaio inox AISI 316
- Parti interne AISI 316 e ottone
- Cilindro oleodinamico in bronzo con leva per il comando di emergenza in AISI 316
- Portata olio 1,6 l/min
- Pressione olio 60 ± 10 bar
- Attacco mediante:
 - FQ 125
 - FQ 150
 - 6" ANSI 150
 - F. BSP
- Esecuzione idonea ad installazione esterna in ambiente marino e funzionamento con acqua mare e soluzioni schiumogene
- Pressione di progetto: 16 bar

Ciclo verniciatura standard SA:

- Pulizia manuale con solvente
- Primer epossidico 60 µm
- Intermedio poliuretano 30 µm
- Finitura poliuretano 30 µm
- Spessore totale film secco 120 µm +/-10%
- Colore rosso RAL 3000

Technical characteristics

- Body material to be selected among
 - Bronze EN 1982 – CC491K
 - Stainless Steel AISI 316
- Inner parts in stainless steel AISI 316 and brass
- Brass hydraulic cylinder with AISI 316 emergency lever
- Oil flow rate required 1,6 lpm
- Oil pressure 60 ± 10 bar
- Connection:
 - SF 125
 - SF 150
 - 6" ANSI 150
 - F. BSP
- Suitable execution for external installation in marine environment and operation with sea water and foam solutions
- Design pressure: 16 bar

Painting system standard SA:

- Manual cleaning solvent
- Epoxy primer 60 µm
- Polyurethane intermediate 30 µm
- Polyurethane finish 30 µm
- Total thickness 120 µm dry film +/-10%
- Colour red RAL 3000

Dimensioni e Pesì

Dimensions and Weights

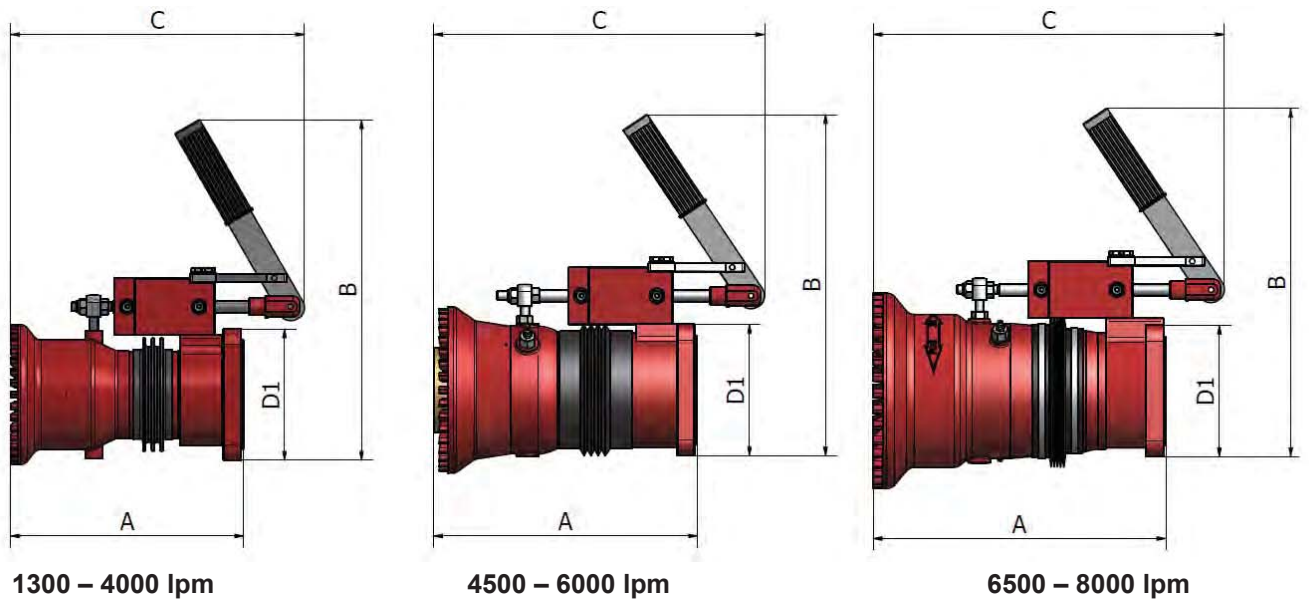

TYPE	Ø D1	A mm	B mm	C mm	Portata Massima (l/min a 7 bar) Max. Flow rate (lpm at 7 bar)														Peso Weight (kg)
					1300	1500	2000	2500	3000	4000	4500	5000	5500	6000	6500	7000	7500	8000	
1300 - 4000	F.BSP 2.1/2"	266	389	336	✓	✓	✓	✓	✓	✓	✗	✗	✗	✗	✗	✗	✗	✗	19
	FQ125 SF125	266	389	336	✓	✓	✓	✓	✓	✓	✗	✗	✗	✗	✗	✗	✗	✗	19
	FQ150 SF150	266	389	336	✓	✓	✓	✓	✓	✓	✗	✗	✗	✗	✗	✗	✗	✗	19.5
4500 - 6000	F.BSP 3"	305	390	380	✗	✗	✗	✗	✗	✗	✓	✓	✓	✓	✗	✗	✗	✗	34
	FQ150 SF150	305	390	380	✗	✗	✗	✗	✗	✗	✓	✓	✓	✓	✗	✗	✗	✗	34.5
6500 - 8000	F.BSP 4"	335	400	405	✗	✗	✗	✗	✗	✗	✗	✗	✗	✗	✓	✓	✓	✓	38
	FQ150 SF150	335	400	405	✗	✗	✗	✗	✗	✗	✗	✗	✗	✗	✓	✓	✓	✓	38.5
	ANSI 150 6"	335	400	405	✗	✗	✗	✗	✗	✗	✗	✗	✗	✗	✓	✓	✓	✓	39

Opzioni

- Ciclo di verniciatura diverso dallo Standard SA
- Per ulteriori opzioni o versioni speciali contattare SA Fire Protection

Optional

- Painting system different from Standard SA
- For additional options or special versions contact SA Fire Protection

Codice Identificativo
Identification Form

OPZIONI / OPTIONS

Mod.

/ / / /

1

2

3

4

5

Quantità / Quantity

BOCCHELLO OLEODINAMICO BNO / HYDRAULIC NOZZLE BNO

CORPO BODY		CONNESSIONE CONNECTION		PORTATA FLOW RATE	
1	Tipologia Type	Oleodinamico getto Pieno/Frazionato Hydraulic Jet/Fog	BNO <input checked="" type="checkbox"/>		
	2	Materiale Material	Bronzo EN 1982 – CC491K Bronze EN 1982 – CC491K	CBG10 <input type="checkbox"/>	
		Acciaio inox AISI 316 Stainless steel AISI 316	CAI12 <input type="checkbox"/>		
3	Tipologia Type	FQ 125 SF 125	125 <input type="checkbox"/>	Disponibile solo per portate fino a 4000 l/min. Available only for flow rate up to 4000 l/min.	
		FQ 150 SF 150	150 <input type="checkbox"/>		
		6" ANSI 150	6 <input type="checkbox"/>	Disponibile solo per portate da 6500 a 8000 l/min. Available only for flow rate from 6500 to 8000 l/min.	
		F. BSP 2 1/2"	2M <input type="checkbox"/>	Disponibile solo per portate fino a 4000 l/min. Available only for flow rate up to 4000 l/min.	
		F. BSP 3"	3 <input type="checkbox"/>	Disponibile solo per portate da 4500 a 6000 l/min. Available only for flow rate from 4500 to 6000 l/min.	
		F. BSP 4"	4 <input type="checkbox"/>	Disponibile solo per portate da 6500 a 8000 l/min. Available only for flow rate from 6500 to 8000 l/min.	
4	Portata a 7 bar Flow rate at 7 bar	1300 l/min	13 <input type="checkbox"/>		
		1500 l/min	15 <input type="checkbox"/>		
		2000 l/min	20 <input type="checkbox"/>		
		2500 l/min	25 <input type="checkbox"/>		
		3000 l/min	30 <input type="checkbox"/>		
		4000 l/min	40 <input type="checkbox"/>		
		4500 l/min	45 <input type="checkbox"/>		
		5000 l/min	50 <input type="checkbox"/>		
		5500 l/min	55 <input type="checkbox"/>		
		6000 l/min	60 <input type="checkbox"/>		
		6500 l/min	65 <input type="checkbox"/>		
		7000 l/min	70 <input type="checkbox"/>		
		7500 l/min	75 <input type="checkbox"/>		
		8000 l/min	80 <input type="checkbox"/>		
Altro Other		F <input type="checkbox"/>	Specificare in Note la portata richiesta. Specify in Notes the flow rate required.		

Prosegue alla pagina seguente / Continue to the next page

OPZIONI OPTIONS	5	Verniciatura Painting	Verniciatura diversa da ciclo SA standard Painting system different for SA standard	C <input type="checkbox"/>	Specificare in Note il ciclo di verniciatura richiesto. Specify in Notes the painting procedure required.	
NOTE NOTES						
	CLIENTE / CLIENT:		PROGETTO / PROJECT:		DOC. No.:	REV.:
	EMESSO / ISSUED:		CONTROLLATO / CHECKED:		APPROVATO / APPROVED:	
DATA / DATE:		DATA / DATE:		DATA / DATE:		

I particolari di questo foglio tecnico, sebbene esatti al tempo della pubblicazione, potrebbero essere soggetti a modifiche senza preavviso. - The data shown on this data sheet, although correct at the time of publication, may be varied without notice.

BOCCELLO ELETTRICO – BNE
ELECTRIC NOZZLE – BNE

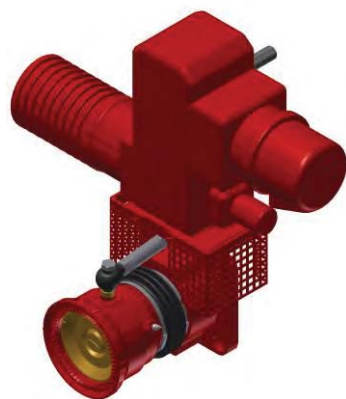

1300 – 4000 lpm

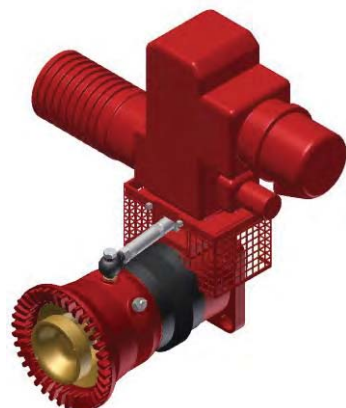

4500 – 6000 lpm

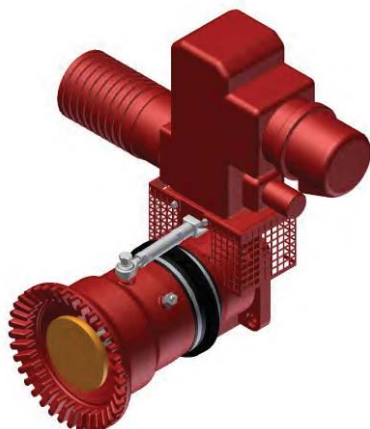

6500 – 8000 lpm

Descrizione



Il bocchello BNE è un dispositivo di regolazione e controllo di flusso a comando manuale ed elettrico che viene montato sui monitori antincendio per generare flussi d'acqua o acqua/schiuma a getto pieno oppure frazionato. Il bocchello può essere regolato da getto pieno a getto frazionato per mezzo di un attuatore elettrico posto sul corpo esterno. L'attuatore agisce sullo scorrimento del corpo superiore su quello inferiore variando l'angolazione del canale di erogazione. In condizioni di pressione costante, la portata rimane costante ma la geometria del getto varia da getto pieno a getto frazionato. Il bocchello BNE è disponibile con quattro attacchi standard diversi: flangia quadra FQ 125, FQ 150, ANSI 150 o F.BSP per il collegamento a monitori da 2 ½", 3" e 4". I materiali di costruzione disponibili variano dalle leghe di bronzo all'acciaio Inox rendendo il bocchello versatile ed idoneo per l'impiego con acqua di mare o soluzioni schiumogene all'interno di ambienti industriali ad alta aggressività o in applicazioni offshore.

Description



The BNE an electric operated nozzle used as flow pattern regulating device on firefighting monitors and capable to project flows of water or water/foam in full jet or fog condition. The nozzle can be adjusted from full jet to fog stream via an electric actuator located on the external nozzle body. The electric actuator causes the nozzle to shift with a consequent variation of the flow impingement angle. At constant pressure, the flow remains constant but the jet geometry varies from full jet to a fog stream. The BNE nozzle is available with three different connections: square flanged SF125, SF150, ANSI 150 or F.BSP for connection with monitors of 2 ½", 3" and 4". The material of construction available varies from bronze alloys to stainless steel making the nozzle suitable for being used with sea water or water foam solution within industrial harsh environments & offshore applications.

Caratteristiche tecniche

- Corpo bocchello a scelta tra:
 - Bronzo EN 1982 – CC491K
 - Acciaio inox AISI 316
- Parti interne AISI 316 e ottone
- Indicatore meccanico di posizione continuo a quadrante
- Attacco mediante:
 - FQ 125
 - FQ 150
 - 6" ANSI 150
 - F. BSP
- Esecuzione idonea ad installazione esterna in ambiente marino e funzionamento con acqua mare e soluzioni schiumogene
- Pressione di progetto 16 bar

Ciclo verniciatura standard SA:

- Pulizia manuale con solvente
- Primer epossidico 60 µm
- Intermedio poliuretano 30 µm
- Finitura poliuretano 30 µm
- Spessore totale film secco 120 µm +/-10%
- Colore rosso RAL 3000

Attuatore

- Movimento FOG/JET realizzato mediante attuatore elettrico ATEX II 2 G Ex d e IIC T4,
- Comando manuale di emergenza per entrambi i movimenti a volantino di sicurezza dis-inseribile (non ruota durante la manovra)
- Resistenza anticondensa
- Indicatore meccanico di posizione continuo con quadrante
- Colore Grigio RAL 7037

Technical characteristics

- Body material to be selected among
 - Bronze EN 1982 – CC491K
 - Stainless Steel AISI 316
- Inner parts in stainless steel AISI 316 and brass
- Mechanical continuous position indicator with quadrant
- Connection:
 - SF 125
 - SF 150
 - 6" ANSI 150
 - F. BSP
- Suitable execution for external installation in marine environment and operation with sea water and foam solutions
- Design pressure: 16 bar

Painting system standard SA:

- Manual cleaning solvent
- Epoxy primer 60 µm
- Polyurethane intermediate 30 µm
- Polyurethane finish 30 µm
- Total thickness 120 µm dry film +/-10%
- Colour red RAL 3000

Actuator

- FOG/JET movement driven by electric actuator ATEX II 2 G Ex d e IIC T4,
- Emergency manual controls for both movements, with disengageable safety hand wheel (does not rotate during operation)
- Anticondensation Resistor
- Mechanical continuous position indicator with quadrant
- Colour Grey RAL 7037

Versioni:
Attuatori convenzionali:
Versione 380 V ca : (BNE)

- Movimento FOG/JET realizzato mediante attuatori elettrici ATEX II 2 G Ex d e IIC T4, alimentazione 380 V 3F 50 Hz – 0,03 Kw – IP 67. Equipaggiato con N° 2 contatti (NA/NC) di massima coppia e N°2 contatti (NA/NC) di fine corsa

Versione 380 V ca SIL2 : (BNES)

- Movimento FOG/JET realizzato mediante attuatori elettrici ATEX II 2 G Ex d e IIC T4, alimentazione 380 V 3F 50 Hz – 0,03 Kw – IP 67. Equipaggiato con N° 2 contatti (NA/NC) di massima coppia e N°2 contatti (NA/NC) di fine corsa
- Sistema: Tipo A
- Operazione: Low Demand
- HFT = 0
- $4,57E-03 < PFDA_{avg} < 6,39E-03$ dipende dalla frequenza di diagnostica
- TI = 1 anno
- I dati si riferiscono all'insieme Attuatore + Monitore

Versione 220 V ca: (BNE220)

- Movimento FOG/JET realizzato mediante attuatori elettrici ATEX II 2 G Ex d e IIC T4, alimentazione 230 V 1F 50 Hz – 0,115 Kw – IP 67. Equipaggiato con N° 2 contatti (NA/NC) di massima coppia e N°2 contatti (NA/NC) di fine corsa

Versione 24 V cc: (BNE24)

- Movimento FOG/JET realizzato mediante attuatori elettrici ATEX II 2 G Ex d e IIC T4, alimentazione 24 V – 0,13 Kw – IP 67. Equipaggiato con N° 2 contatti (NA/NC) di massima coppia e N°2 contatti (NA/NC) di fine corsa

Version:
Conventional actuators:
380 V ac Version: (BNE)

- FOG/JET movement driven by electric actuators ATEX II 2 G Ex d e IIC T4, supply voltage 380 V 3Ph 50 Hz – 0,03 Kw – IP 67. Equipped with N° 2 torque limit contacts (NA/NC) and N°2 limit switch (NA/NC)

380 V ac SIL2 Version: (BNES)

- FOG/JET movement driven by electric actuators ATEX II 2 G Ex d e IIC T4, supply voltage 380 V 3Ph 50 Hz – 0,03 Kw – IP 67. Equipped with N° 2 torque limit contacts (NA/NC) and N°2 limit switch (NA/NC)
- System: Type A
- Operation Low demand
- HFT = 0
- $4,57E-03 < PFDA_{avg} < 6,39E-03$ depending on diagnostic test frequency
- TI = 1 year
- Data are referred to the assembly Actuators + Monitors

220 V ac Version: (BNE220)

- FOG/JET movement driven by electric actuators ATEX II 2 G Ex d e IIC T4, supply voltage 230 V 1Ph 50 Hz – 0,115 Kw – IP 67. Equipped with N° 2 torque limit contacts (NA/NC) and N°2 limit switch (NA/NC)

24 V dc Version: (BNE24)

- FOG/JET movement driven by an electric actuators ATEX II 2 G Ex d e IIC T4, supply voltage 24 V – 0,13 Kw – IP 67. Equipped with N° 2 torque limit contacts (NA/NC) and N°2 limit switch (NA/NC)

Versioni:
Attuatori Profibus:

- Movimento FOG/JET realizzato mediante attuatori elettrici ATEX II 2 G Ex d e IIC T4. Equipaggiato con:
- N° 1 Unità di controllo a taratura non intrusiva MWG ad encoder assoluto interagente con l'unità di controllo AUMATIC per funzioni di:
 - Fine corsa per le posizioni di Aperto e Chiuso.
 - Limitatore di coppia per Apertura e Chiusura.
 - Trasmettitore di posizione.
 - Funzione di segnalazioni intermedie.
- N° 1 Unità di controllo integrale AUMATIC con microprocessore e interfaccia seriale Profibus DP che include:
 - Coppia di contattori con interblocchi elettrici e meccanici.
 - Tensione di uscita: 24VCC max 100mA (galvanicamente isolata).
 - N° 1 Ingresso analogico 0/4-20mA per posizionamento percentuale della valvola.
 - Segnalazione di posizione 0/4-20mA con separazione galvanica (carico massimo 500ohm).
 - Segnalazione di misura coppia 0/4-20mA con separazione galvanica (carico massimo 500ohm).
 - N° 6 Ingressi digitali (24V) per: Apertura-Stop-Chiusura
 - ESD (programmabile)
 - Mode-Interface per selezione priorità input.
 - Scheda di interfaccia seriale Profibus DP-V0 in accordo alle EN50170
 - Selettore di posizione non intrusivo Locale/off/Remoto lucchettabile in ciascuna posizione.
 - Pulsantiera locale non intrusiva con pulsanti Apri-Stop-Chiudi-Reset e 6 led di indicazione
 - Display grafico per indicazione parametri di programmazione del microprocessore e visualizzazione dati memorizzati
 - Interfaccia di comunicazione via bluetooth.
- Resistenza anticondensa
- Indicatore meccanico di posizione continuo con quadrante

Versione 380 V ca Profibus: (BNEPB)

- Movimento FOG/JET realizzato mediante attuatori elettrici ATEX II 2 G Ex d e IIC T4, alimentazione 380 V 3Ph 50 Hz – IP 67.

Versione 220 V ca Profibus: (BNE220PB)

- Movimento FOG/JET realizzato mediante attuatori elettrici ATEX II 2 G Ex d e IIC T4, alimentazione 220 V 1Ph 50 Hz – IP 67.

Version:
Profibus actuators:

- FOG/JET movement driven by electric actuators ATEX II 2 G Ex d e IIC T4. Equipped with:
- N° 1 encoder calibration control unit MWG connected with AUMATIC control unit for:
 - Open/Close Position indication
 - Torque limitation
 - Position Transmitter
 - Intermediate status signal
- N° 1 integral control AUMATIC with microprocessor and serial interface Profibus including:
 - Electric an mechanical interlock connectors
 - Outlet Voltage 24 VCC max 100 mA (galvanic isolated)
 - N° 1 Analogue input 0/4-20 mA for percentual position of the valve
 - N° 1 Analogue output 0/4-20 mA with galvanic segregation (max. load 500 ohm) for position indicator
 - N° 1 Analogue output 0/4-20 mA with galvanic segregation (max. load 500 ohm) for torque measurement
 - N° 6 digital input 24 V available for: Open-Close-Stop
 - ESD Programmable
 - Mode-Interface for selecting input priorities
 - Interface board Profibus DP-V0 EN 50170 compliant
 - Non-intrusive position selector Local/off/Remote, lockable in each position.
 - Non-intrusive local push-buttons Open-Stop-Close-Reset with 6 LED for indication.
 - Graphic Display indicating programming parameters and data visualization
 - Bluetooth Interface
- Anti-condensation Resistor
- Mechanical continuous position indicator with quadrant

Profibus 380 V ac Version: (BNEPB)

- FOG/JET movement driven by electric actuators ATEX II 2 G Ex d e IIC T4, supply voltage 380 V 3Ph 50 Hz – IP 67.

Profibus 220 V ac Version: (BNE220PB)

- FOG/JET movement driven by electric actuators ATEX II 2 G Ex d e IIC T4, supply voltage 220 V 1Ph 50 Hz – IP 67.

Dimensioni e Pesì (1)

Dimensions and Weights (1)

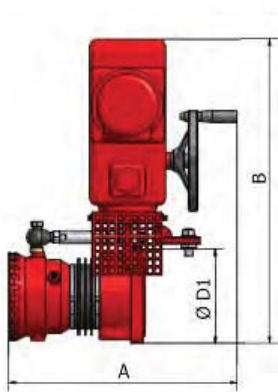

1300 – 4000 lpm

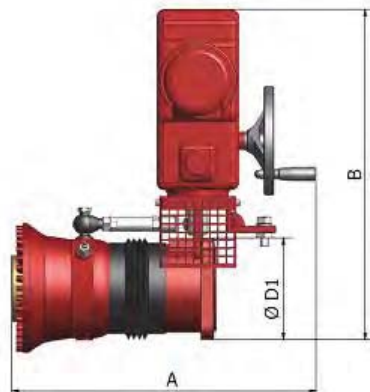

4500 – 6000 lpm

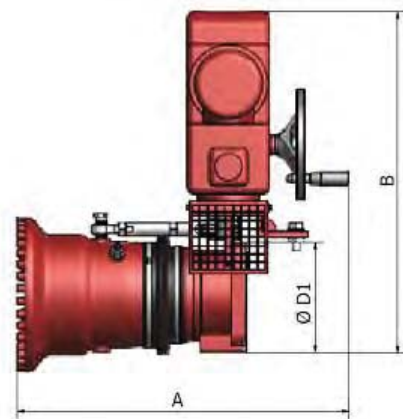

6500 – 8000 lpm

TYPE	Ø D1	A mm	B mm	Portata Massima (l/min a 7 bar) Max. Flow rate (lpm at 7 bar)														Peso Weight (kg)
				1300	1500	2000	2500	3000	4000	4500	5000	5500	6000	6500	7000	7500	8000	
1300 – 4000	F.BSP 2.1/2"	400	485	✓	✓	✓	✓	✓	✓	✗	✗	✗	✗	✗	✗	✗	✗	40
	FQ125 SF125	400	485	✓	✓	✓	✓	✓	✓	✗	✗	✗	✗	✗	✗	✗	✗	40,5
	FQ150 SF150	400	485	✓	✓	✓	✓	✓	✓	✗	✗	✗	✗	✗	✗	✗	✗	41
4500 – 6000	F.BSP 3"	450	485	✗	✗	✗	✗	✗	✗	✓	✓	✓	✓	✗	✗	✗	✗	50
	FQ150 SF150	450	485	✗	✗	✗	✗	✗	✗	✓	✓	✓	✓	✗	✗	✗	✗	50,5
6500 – 8000	F.BSP 4"	495	485	✗	✗	✗	✗	✗	✗	✗	✗	✗	✗	✓	✓	✓	✓	58
	FQ150 SF150	495	485	✗	✗	✗	✗	✗	✗	✗	✗	✗	✗	✓	✓	✓	✓	58,5
	ANSI 150 6"	495	485	✗	✗	✗	✗	✗	✗	✗	✗	✗	✗	✓	✓	✓	✓	59

Opzioni

- Ciclo di verniciatura diverso dallo Standard SA
- Per ulteriori opzioni o versioni speciali contattare SA Fire Protection

Optional

- Painting system different from Standard SA
- For additional options or special versions contact SA Fire Protection

Nota:

(1) Outline riferito alla versione standard, per la versione Profibus Contattare SA Fire Protection per maggiori dettagli.

Note:

(1) Outline are referred to the standard version, for the Profibus version contact SA Fire Protection for additional details.

**Codice Identificativo
Identification Form**

OPZIONI / OPTIONS

Mod.

/ / / /

1

2

3

4

5

Quantità / Quantity

BOCCHELLO ELETTRICO BNE / ELETTRIC NOZZLE BNE

CORPO BODY	1	Tipologia Type	Standard 380 Vca 3F 50Hz Standard 380 Vac 3 Ph. 50Hz	BNE <input type="checkbox"/>	
			Versione SIL2 380 Vca 3F 50Hz SIL2 version 380 Vac 3 Ph. 50Hz	BNES <input type="checkbox"/>	
			Versione 220 Vca 1F 50 Hz Version 220 Vac 1Ph. 50 Hz	BNE220 <input type="checkbox"/>	
			Versione 24 Vcc Version 24 Vdc	BNE24 <input type="checkbox"/>	
			Standard Profibus 380 Vca 3F 50Hz Standard Profibus 380 Vac 3 Ph. 50Hz	BNEPB <input type="checkbox"/>	
			Versione Profibus 220 Vca 1F 50 Hz Version Profibus 220 Vac 1Ph. 50 Hz	BNE220PB <input type="checkbox"/>	
			Altro Other	BNEC <input type="checkbox"/>	Specificare in Note la tipologia di alimentazione elettrica richiesta. Specify in Notes the type of power supply requested.
2	Materiale Material	Bronzo EN 1982 – CC491K Bronze EN 1982 – CC491K	CBG10 <input type="checkbox"/>		
		Acciaio inox AISI 316 Stainless steel AISI 316	CAI12 <input type="checkbox"/>		
CONNESSIONE CONNECTION	3	Tipologia Type	FQ 125 SF 125	125 <input type="checkbox"/>	Disponibile solo per portate fino a 4000 l/min. Available only for flow rate up to 4000 l/min.
			FQ 150 SF 150	150 <input type="checkbox"/>	
			6" ANSI 150	6 <input type="checkbox"/>	Disponibile solo per portate da 6500 a 8000 l/min. Available only for flow rate from 6500 to 8000 l/min
			F. BSP 2 1/2"	2M <input type="checkbox"/>	Disponibile solo per portate fino a 4000 l/min. Available only for flow rate up to 4000 l/min.
			F. BSP 3"	3 <input type="checkbox"/>	Disponibile solo per portate da 4500 a 6000 l/min. Available only for flow rate from 4500 to 6000 l/min.
			F. BSP 4"	4 <input type="checkbox"/>	Disponibile solo per portate da 6500 a 8000 l/min. Available only for flow rate from 6500 to 8000 l/min.
PORTATA FLOW RATE	4	Portata a 7 bar Flow rate at 7 bar	1300 l/min	13 <input type="checkbox"/>	
			1500 l/min	15 <input type="checkbox"/>	
			2000 l/min	20 <input type="checkbox"/>	
			2500 l/min	25 <input type="checkbox"/>	
			3000 l/min	30 <input type="checkbox"/>	
			4000 l/min	40 <input type="checkbox"/>	
			4500 l/min	45 <input type="checkbox"/>	
			5000 l/min	50 <input type="checkbox"/>	
			5500 l/min	55 <input type="checkbox"/>	
AF L	4	Portata a 7 bar Flow rate at 7 bar	6000 l/min	60 <input type="checkbox"/>	

			6500 l/min	65 <input type="checkbox"/>	
			7000 l/min	70 <input type="checkbox"/>	
			7500 l/min	75 <input type="checkbox"/>	
			8000 l/min	80 <input type="checkbox"/>	
			Altro Other	F <input type="checkbox"/>	Specificare in Note la portata richiesta. Specify in Notes the flow rate required.
OPZIONI OPTIONS	5	Verniciatura Painting	Verniciatura diversa da ciclo SA standard Painting system different for SA standard	C <input type="checkbox"/>	Specificare in Note il ciclo di verniciatura richiesto. Specify in Notes the painting procedure required.

NOTE NOTES	

CLIENTE / CLIENT:	PROGETTO / PROJECT:	DOC. No.:	REV.:
-------------------	---------------------	-----------	-------

EMESSO / ISSUED:	CONTROLLATO / CHECKED:	APPROVATO / APPROVED:
------------------	------------------------	-----------------------

DATA / DATE:	DATA / DATE:	DATA / DATE:
--------------	--------------	--------------

I particolari di questo foglio tecnico, sebbene esatti al tempo della pubblicazione, potrebbero essere soggetti a modifiche senza preavviso. - The data shown on this data sheet, although correct at the time of publication, may be varied without notice.

Diagrammi Prestazioni | Performance Diagrams

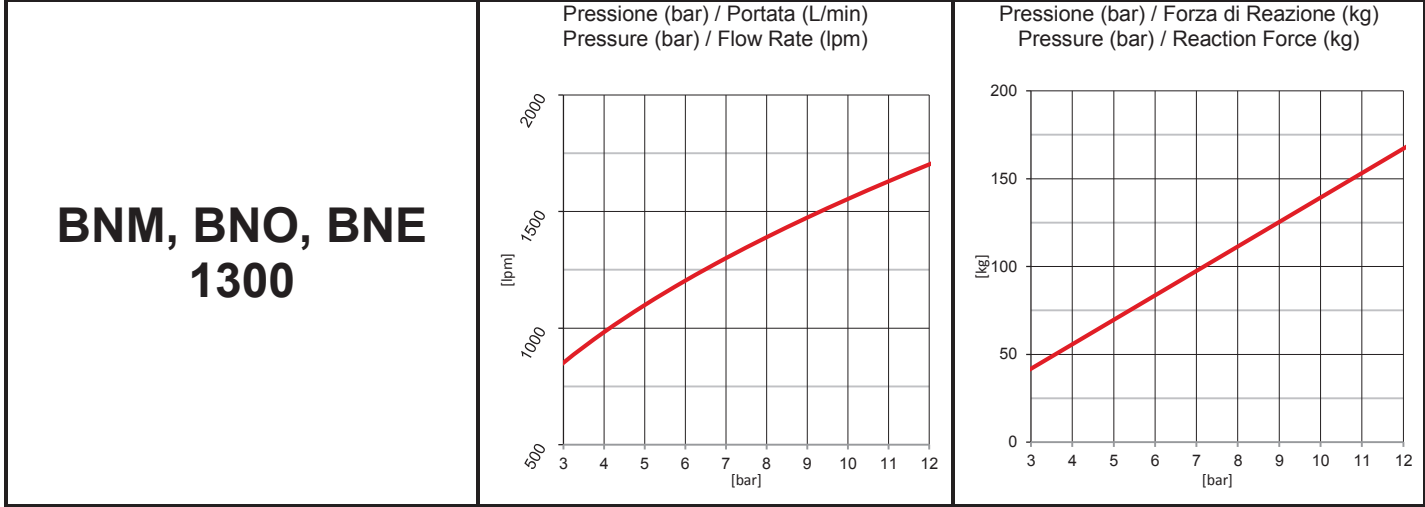

GETTO PIENO / FULL JET GETTO FRAZIONATO 30° / FOG 30° GETTO FRAZIONATO 60° / FOG 60°

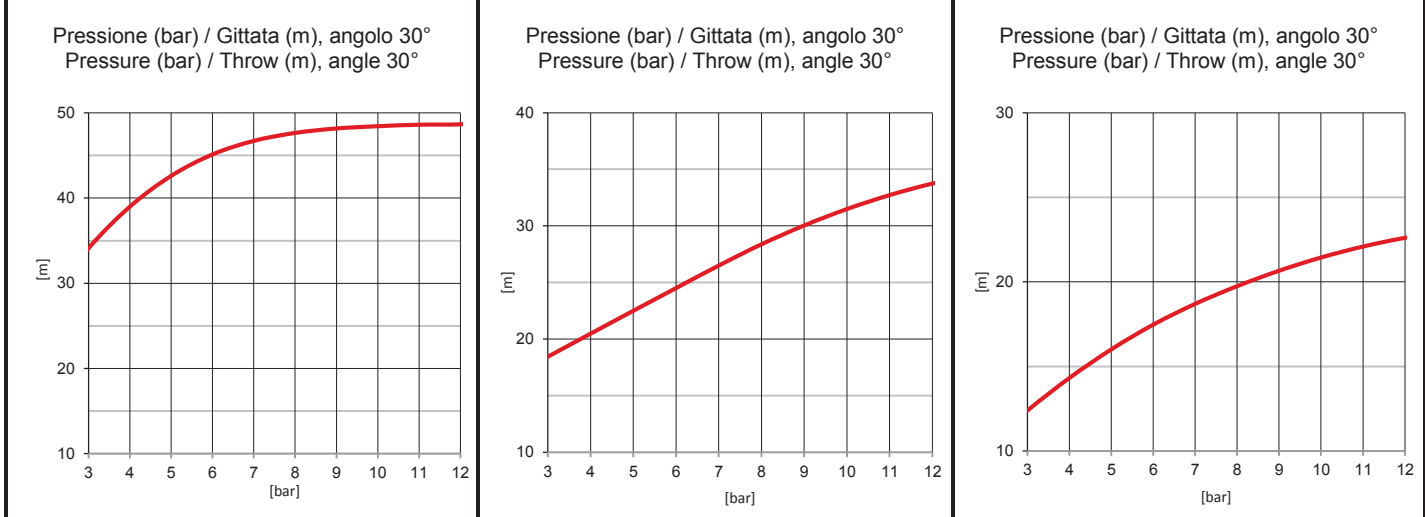

GETTO PIENO / FULL JET GETTO FRAZIONATO 30° / FOG 30° GETTO FRAZIONATO 60° / FOG 60°

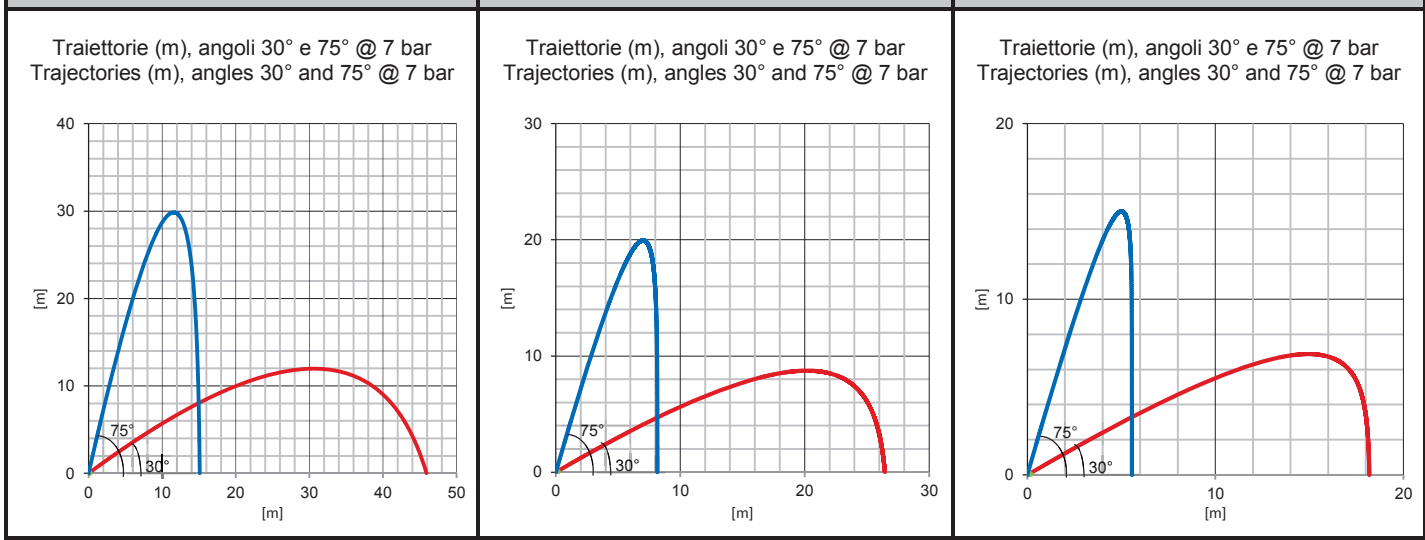

Diagrammi Prestazioni

Performance Diagrams

BNM, BNO, BNE 1500

Pressione (bar) / Portata (L/min)
Pressure (bar) / Flow Rate (lpm)

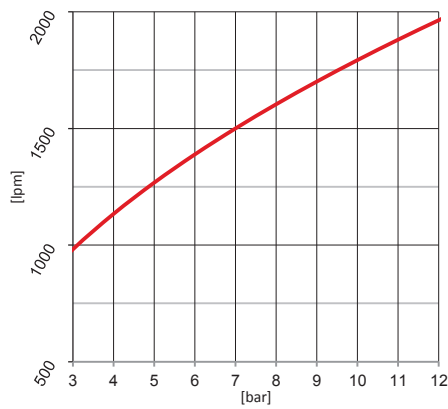

Pressione (bar) / Forza di Reazione (kg)
Pressure (bar) / Reaction Force (kg)

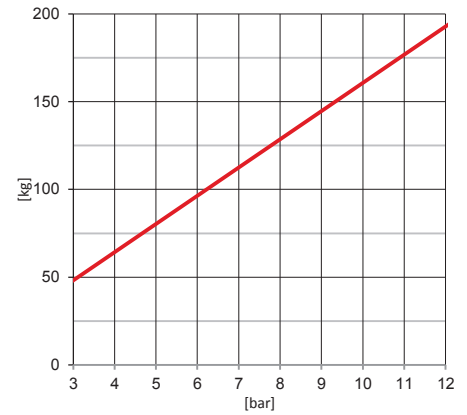

GETTO PIENO / FULL JET

GETTO FRAZIONATO 30° / FOG 30°

GETTO FRAZIONATO 60° / FOG 60°

Pressione (bar) / Gittata (m), angolo 30°
Pressure (bar) / Throw (m), angle 30°

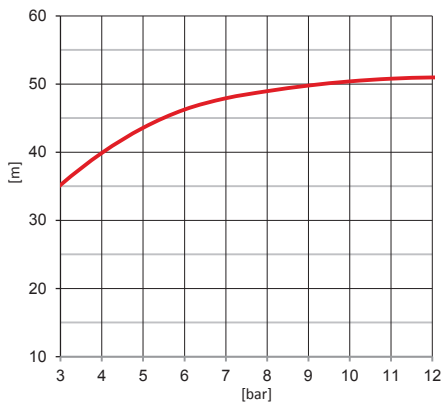

Pressione (bar) / Gittata (m), angolo 30°
Pressure (bar) / Throw (m), angle 30°

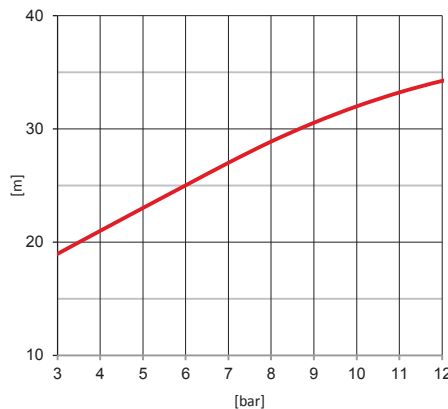

Pressione (bar) / Gittata (m), angolo 30°
Pressure (bar) / Throw (m), angle 30°

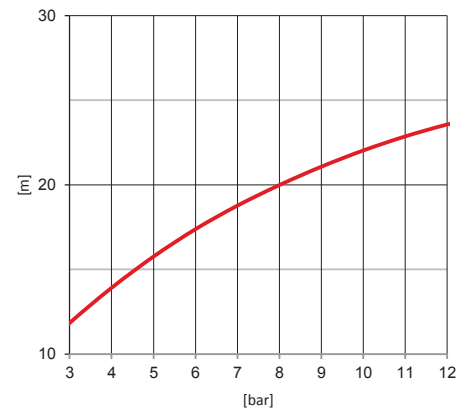

GETTO PIENO / FULL JET

GETTO FRAZIONATO 30° / FOG 30°

GETTO FRAZIONATO 60° / FOG 60°

Traiettorie (m), angoli 30° e 75° @ 7 bar
Trajectories (m), angles 30° and 75° @ 7 bar

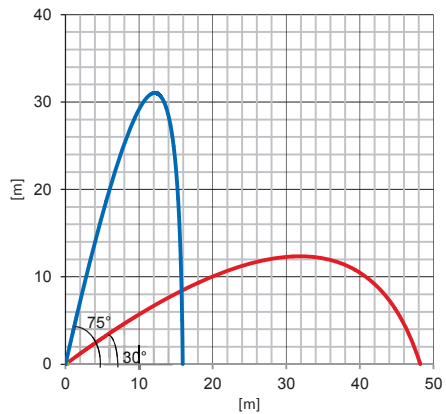

Traiettorie (m), angoli 30° e 75° @ 7 bar
Trajectories (m), angles 30° and 75° @ 7 bar

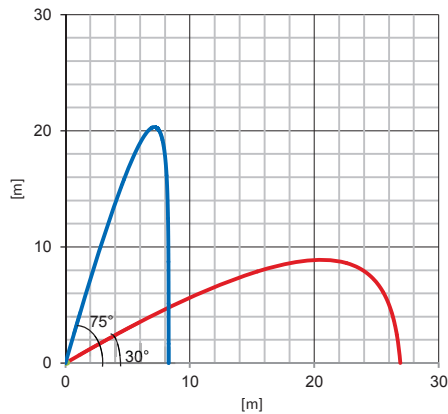

Traiettorie (m), angoli 30° e 75° @ 7 bar
Trajectories (m), angles 30° and 75° @ 7 bar

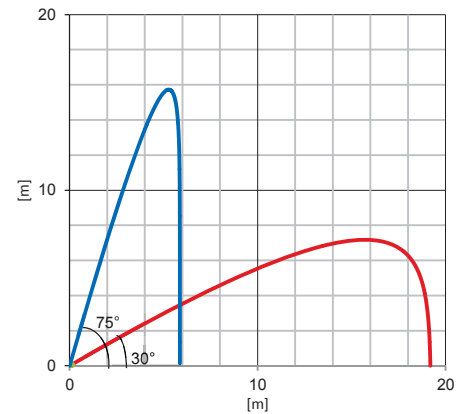

Diagrammi Prestazioni

Performance Diagrams

BNM, BNO, BNE 2000

Pressione (bar) / Portata (L/min)
Pressure (bar) / Flow Rate (lpm)

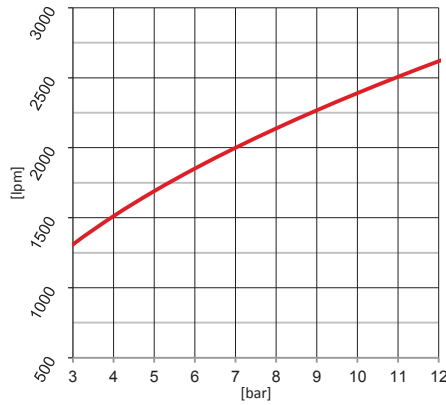

Pressione (bar) / Forza di Reazione (kg)
Pressure (bar) / Reaction Force (kg)

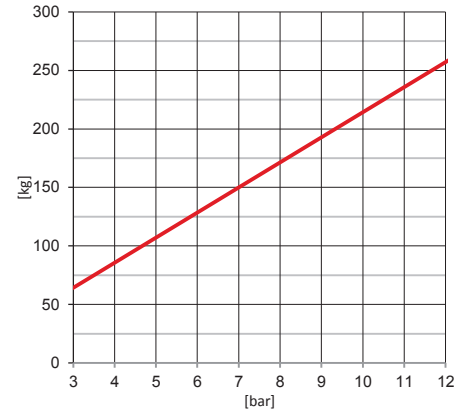

GETTO PIENO / FULL JET

GETTO FRAZIONATO 30° / FOG 30°

GETTO FRAZIONATO 60° / FOG 60°

Pressione (bar) / Gittata (m), angolo 30°
Pressure (bar) / Throw (m), angle 30°

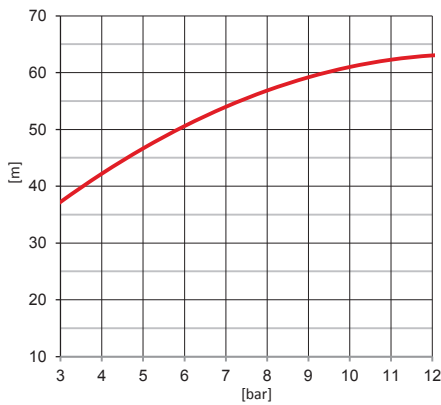

Pressione (bar) / Gittata (m), angolo 30°
Pressure (bar) / Throw (m), angle 30°

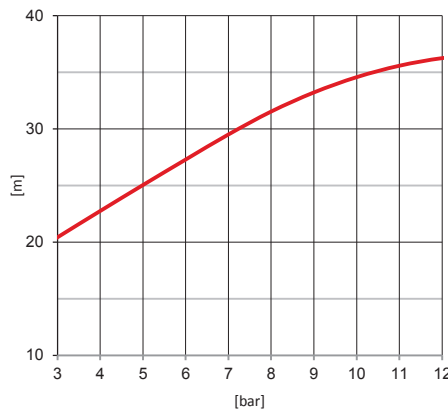

Pressione (bar) / Gittata (m), angolo 30°
Pressure (bar) / Throw (m), angle 30°

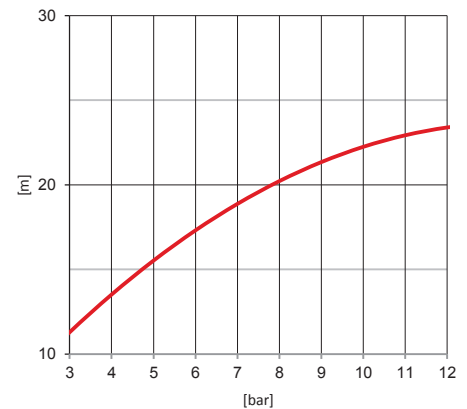

GETTO PIENO / FULL JET

GETTO FRAZIONATO 30° / FOG 30°

GETTO FRAZIONATO 60° / FOG 60°

Traiettorie (m), angoli 30° e 75° @ 7 bar
Trajectories (m), angles 30° and 75° @ 7 bar

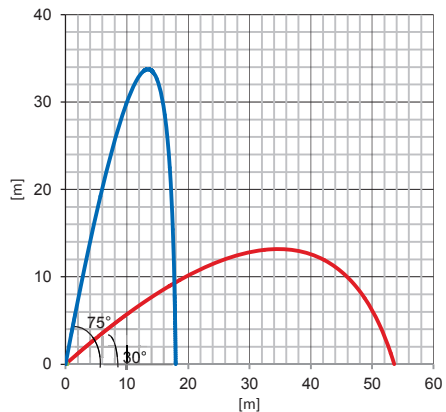

Traiettorie (m), angoli 30° e 75° @ 7 bar
Trajectories (m), angles 30° and 75° @ 7 bar

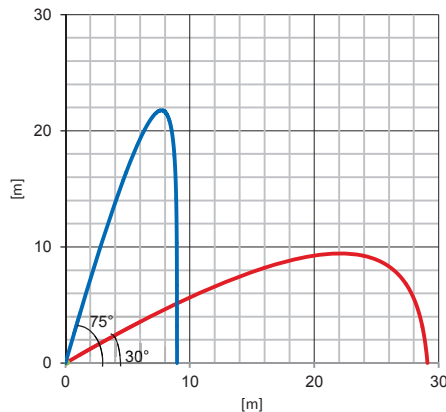

Traiettorie (m), angoli 30° e 75° @ 7 bar
Trajectories (m), angles 30° and 75° @ 7 bar

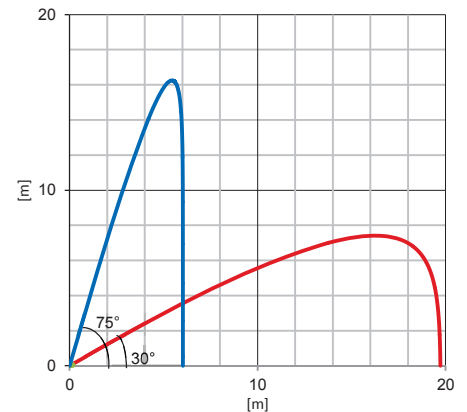

Diagrammi Prestazioni

Performance Diagrams

BNM, BNO, BNE 2500

Pressione (bar) / Portata (L/min)
Pressure (bar) / Flow Rate (lpm)

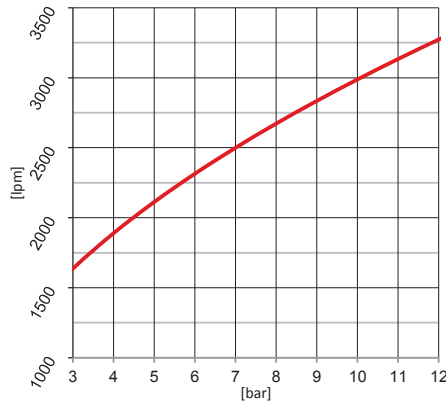

Pressione (bar) / Forza di Reazione (kg)
Pressure (bar) / Reaction Force (kg)

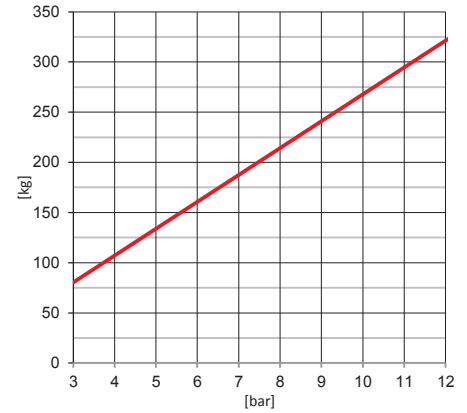

GETTO PIENO / FULL JET

GETTO FRAZIONATO 30° / FOG 30°

GETTO FRAZIONATO 60° / FOG 60°

Pressione (bar) / Gittata (m), angolo 30°
Pressure (bar) / Throw (m), angle 30°

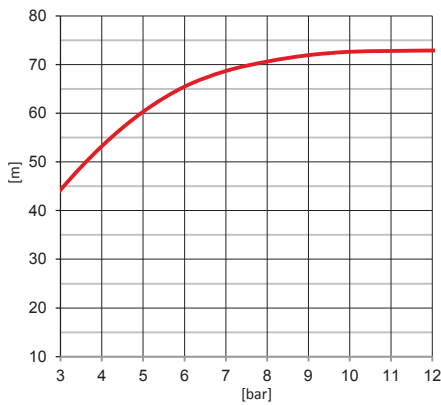

Pressione (bar) / Gittata (m), angolo 30°
Pressure (bar) / Throw (m), angle 30°

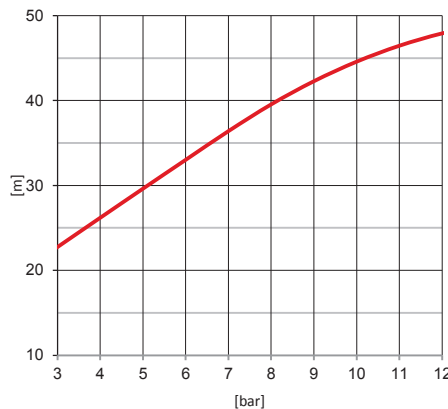

Pressione (bar) / Gittata (m), angolo 30°
Pressure (bar) / Throw (m), angle 30°

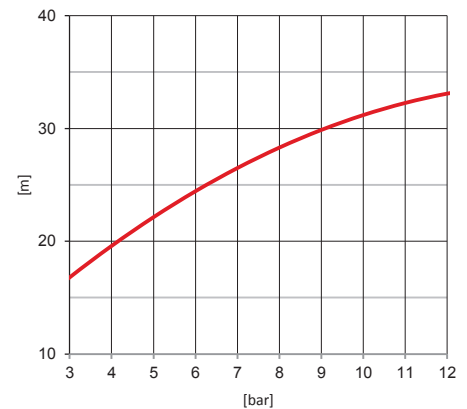

GETTO PIENO / FULL JET

GETTO FRAZIONATO 30° / FOG 30°

GETTO FRAZIONATO 60° / FOG 60°

Traiettorie (m), angoli 30° e 75° @ 7 bar
Trajectories (m), angles 30° and 75° @ 7 bar

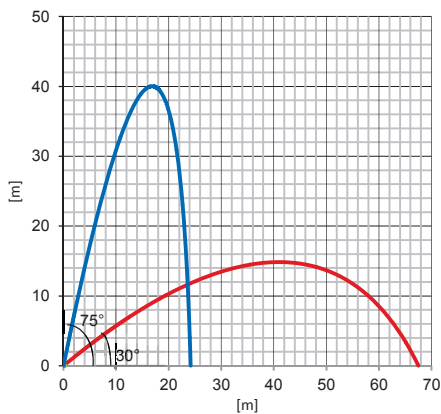

Traiettorie (m), angoli 30° e 75° @ 7 bar
Trajectories (m), angles 30° and 75° @ 7 bar

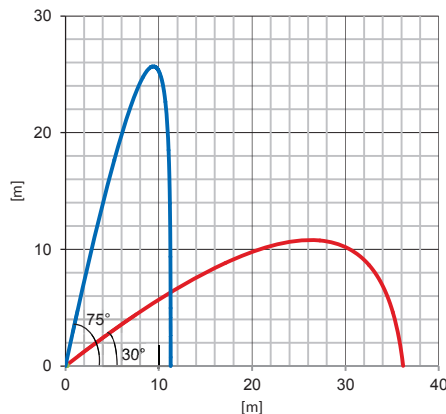

Traiettorie (m), angoli 30° e 75° @ 7 bar
Trajectories (m), angles 30° and 75° @ 7 bar

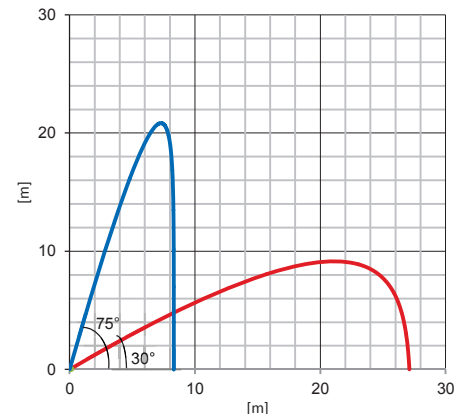

Diagrammi Prestazioni

Performance Diagrams

BNM, BNO, BNE 3000

Pressione (bar) / Portata (L/min)
Pressure (bar) / Flow Rate (lpm)

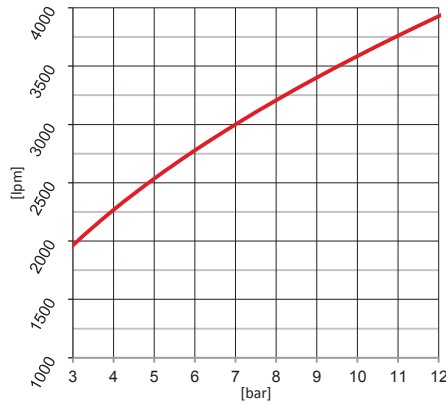

Pressione (bar) / Forza di Reazione (kg)
Pressure (bar) / Reaction Force (kg)

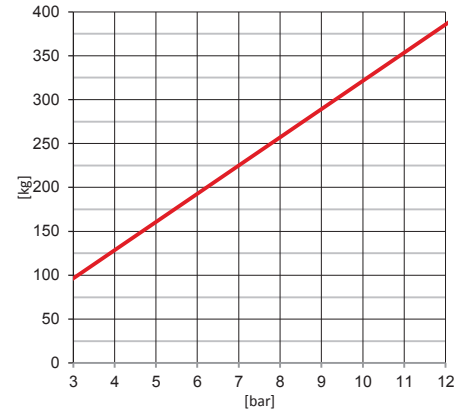

GETTO PIENO / FULL JET

GETTO FRAZIONATO 30° / FOG 30°

GETTO FRAZIONATO 60° / FOG 60°

Pressione (bar) / Gittata (m), angolo 30°
Pressure (bar) / Throw (m), angle 30°

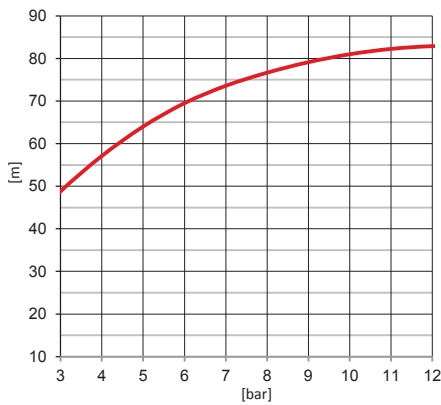

Pressione (bar) / Gittata (m), angolo 30°
Pressure (bar) / Throw (m), angle 30°

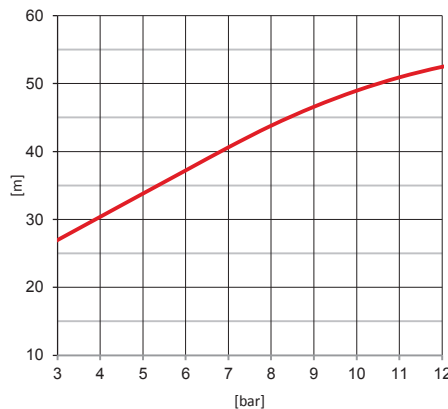

Pressione (bar) / Gittata (m), angolo 30°
Pressure (bar) / Throw (m), angle 30°

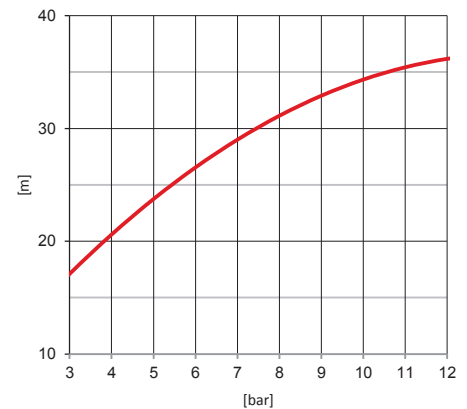

GETTO PIENO / FULL JET

GETTO FRAZIONATO 30° / FOG 30°

GETTO FRAZIONATO 60° / FOG 60°

Traiettorie (m), angoli 30° e 75° @ 7 bar
Trajectories (m), angles 30° and 75° @ 7 bar

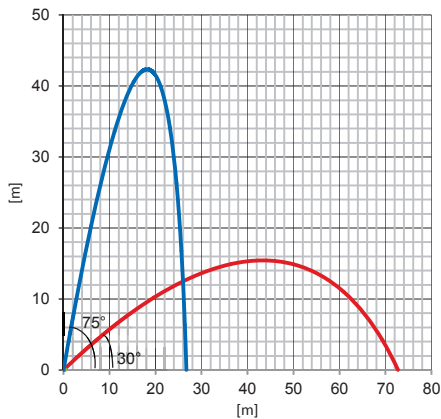

Traiettorie (m), angoli 30° e 75° @ 7 bar
Trajectories (m), angles 30° and 75° @ 7 bar

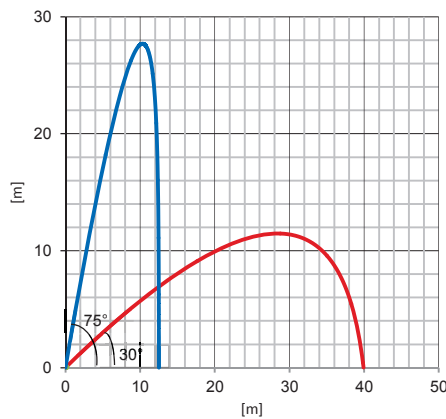

Traiettorie (m), angoli 30° e 75° @ 7 bar
Trajectories (m), angles 30° and 75° @ 7 bar

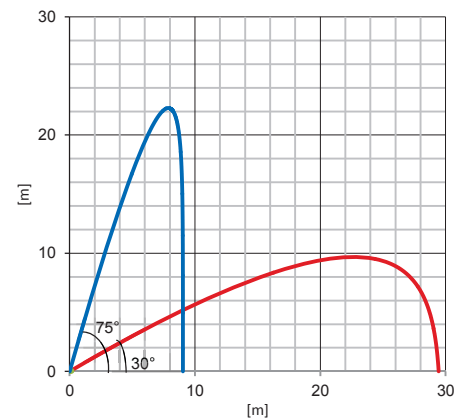

Diagrammi Prestazioni

Performance Diagrams

BNM, BNO, BNE 4000

Pressione (bar) / Portata (L/min)
Pressure (bar) / Flow Rate (lpm)

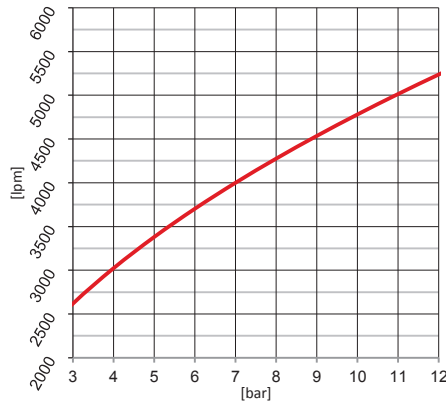

Pressione (bar) / Forza di Reazione (kg)
Pressure (bar) / Reaction Force (kg)

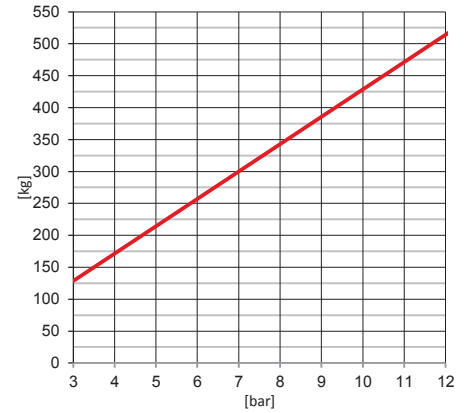

GETTO PIENO / FULL JET

GETTO FRAZIONATO 30° / FOG 30°

GETTO FRAZIONATO 60° / FOG 60°

Pressione (bar) / Gittata (m), angolo 30°
Pressure (bar) / Throw (m), angle 30°

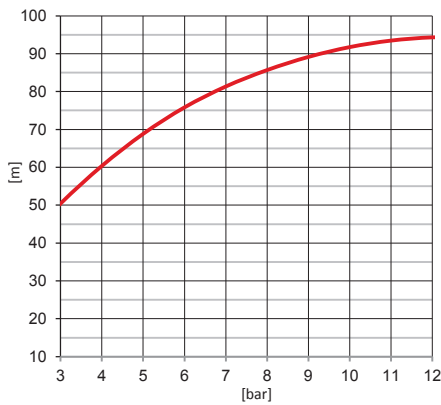

Pressione (bar) / Gittata (m), angolo 30°
Pressure (bar) / Throw (m), angle 30°

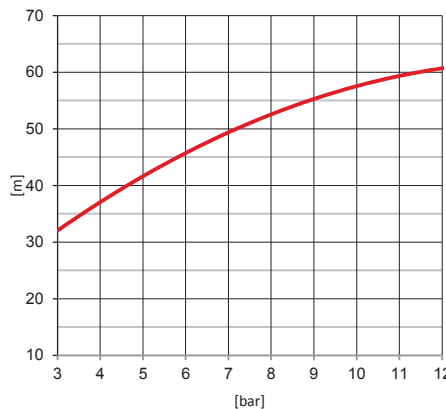

Pressione (bar) / Gittata (m), angolo 30°
Pressure (bar) / Throw (m), angle 30°

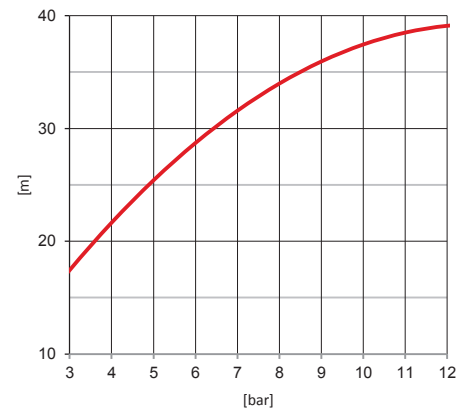

GETTO PIENO / FULL JET

GETTO FRAZIONATO 30° / FOG 30°

GETTO FRAZIONATO 60° / FOG 60°

Traiettorie (m), angoli 30° e 75° @ 7 bar
Trajectories (m), angles 30° and 75° @ 7 bar

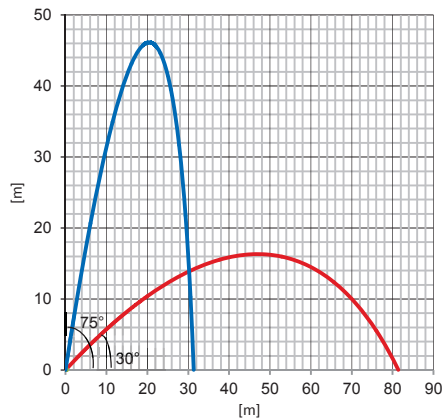

Traiettorie (m), angoli 30° e 75° @ 7 bar
Trajectories (m), angles 30° and 75° @ 7 bar

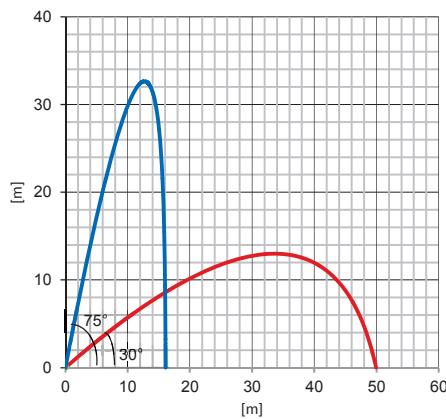

Traiettorie (m), angoli 30° e 75° @ 7 bar
Trajectories (m), angles 30° and 75° @ 7 bar

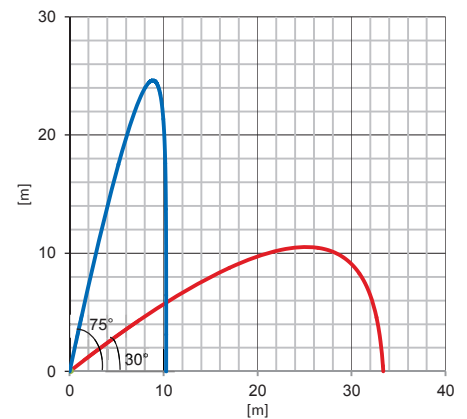

Diagrammi Prestazioni

Performance Diagrams

BNM, BNO, BNE 4500

Pressione (bar) / Portata (L/min)
Pressure (bar) / Flow Rate (lpm)

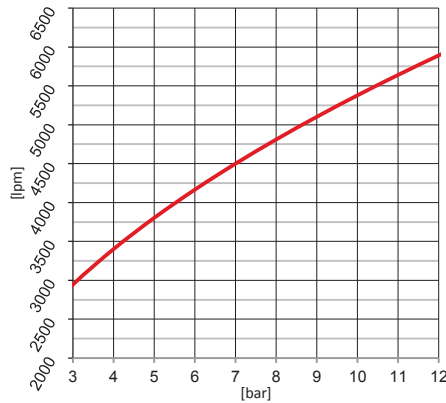

Pressione (bar) / Forza di Reazione (kg)
Pressure (bar) / Reaction Force (kg)

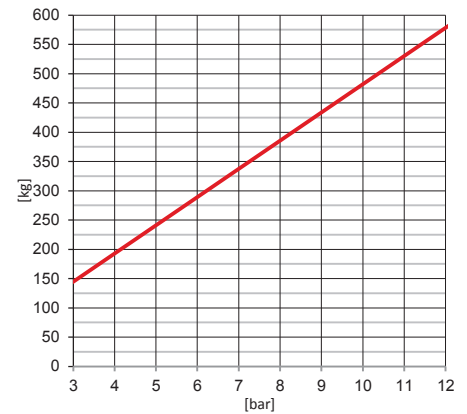

GETTO PIENO / FULL JET

GETTO FRAZIONATO 30° / FOG 30°

GETTO FRAZIONATO 60° / FOG 60°

Pressione (bar) / Gittata (m), angolo 30°
Pressure (bar) / Throw (m), angle 30°

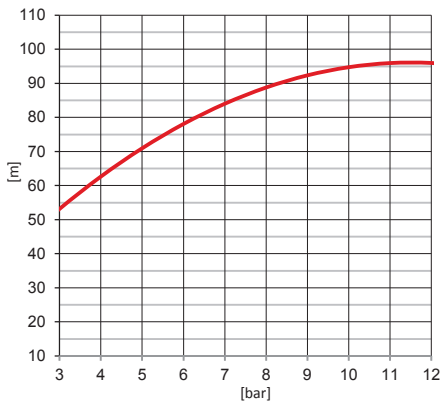

Pressione (bar) / Gittata (m), angolo 30°
Pressure (bar) / Throw (m), angle 30°

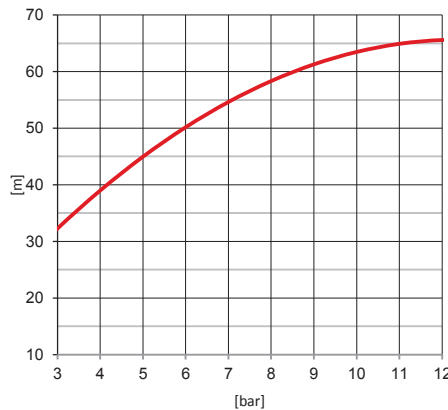

Pressione (bar) / Gittata (m), angolo 30°
Pressure (bar) / Throw (m), angle 30°

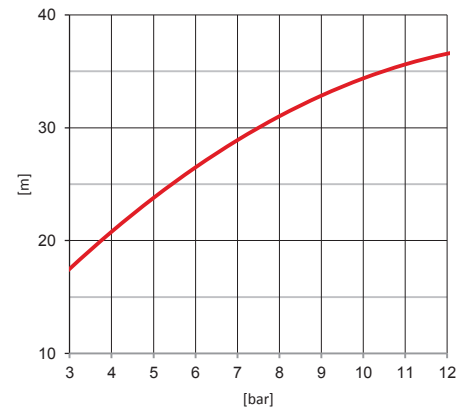

GETTO PIENO / FULL JET

GETTO FRAZIONATO 30° / FOG 30°

GETTO FRAZIONATO 60° / FOG 60°

Traiettorie (m), angoli 30° e 75° @ 7 bar
Trajectories (m), angles 30° and 75° @ 7 bar

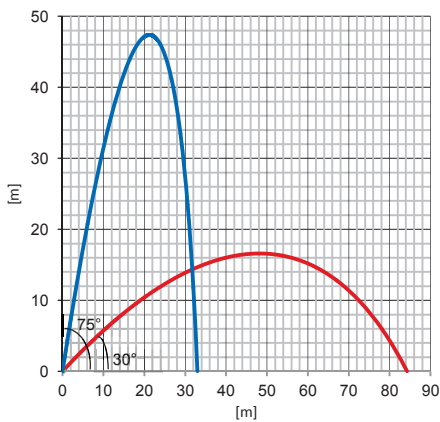

Traiettorie (m), angoli 30° e 75° @ 7 bar
Trajectories (m), angles 30° and 75° @ 7 bar

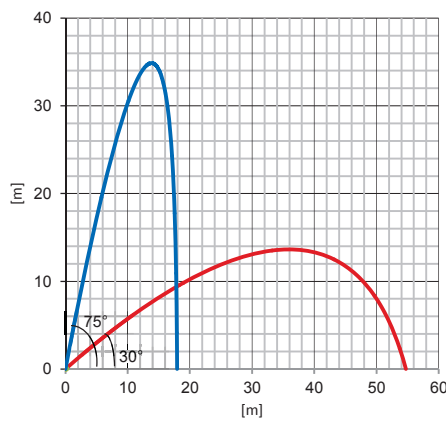

Traiettorie (m), angoli 30° e 75° @ 7 bar
Trajectories (m), angles 30° and 75° @ 7 bar

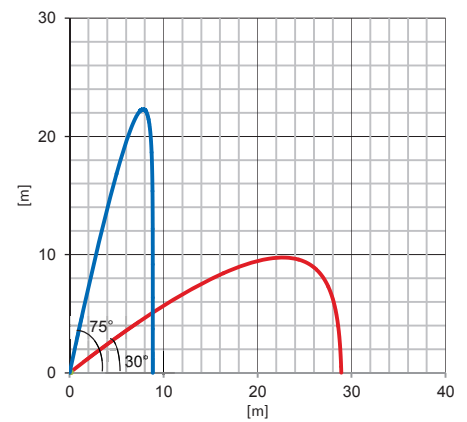

Diagrammi Prestazioni

Performance Diagrams

BNM, BNO, BNE 5000

Pressione (bar) / Portata (L/min)
Pressure (bar) / Flow Rate (lpm)

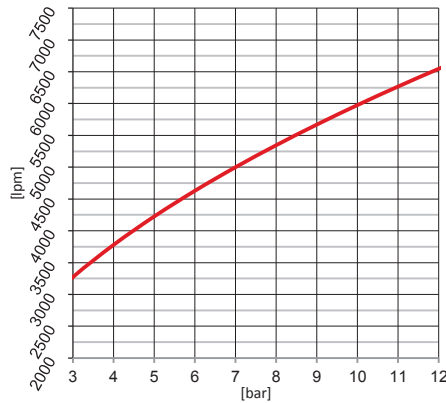

Pressione (bar) / Forza di Reazione (kg)
Pressure (bar) / Reaction Force (kg)

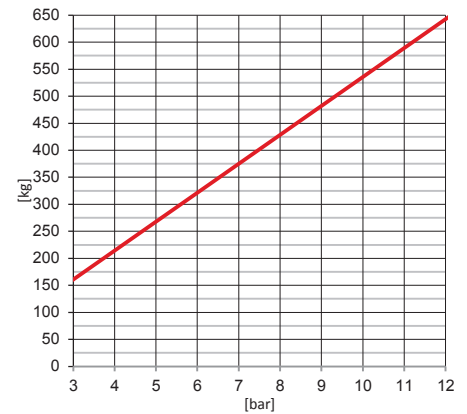

GETTO PIENO / FULL JET

GETTO FRAZIONATO 30° / FOG 30°

GETTO FRAZIONATO 60° / FOG 60°

Pressione (bar) / Gittata (m), angolo 30°
Pressure (bar) / Throw (m), angle 30°

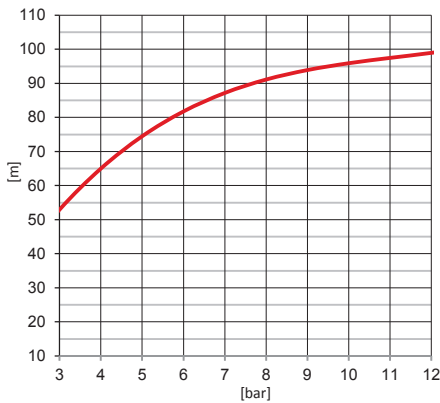

Pressione (bar) / Gittata (m), angolo 30°
Pressure (bar) / Throw (m), angle 30°

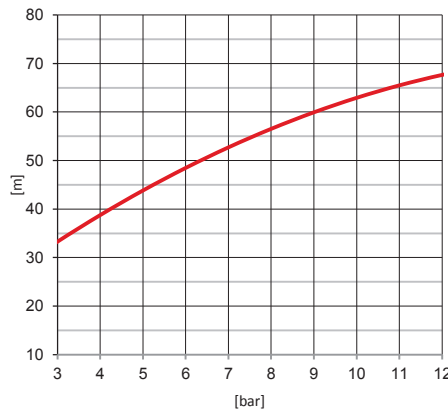

Pressione (bar) / Gittata (m), angolo 30°
Pressure (bar) / Throw (m), angle 30°

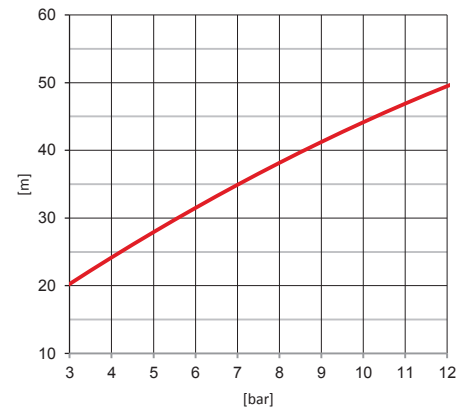

GETTO PIENO / FULL JET

GETTO FRAZIONATO 30° / FOG 30°

GETTO FRAZIONATO 60° / FOG 60°

Traiettorie (m), angoli 30° e 75° @ 7 bar
Trajectories (m), angles 30° and 75° @ 7 bar

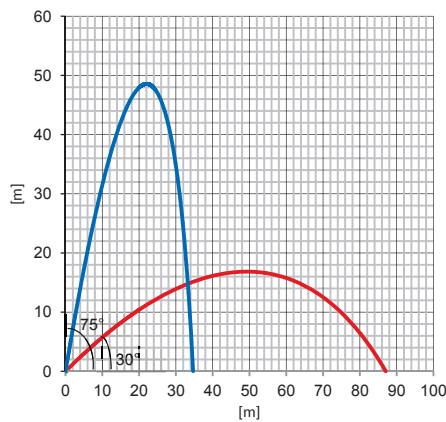

Traiettorie (m), angoli 30° e 75° @ 7 bar
Trajectories (m), angles 30° and 75° @ 7 bar

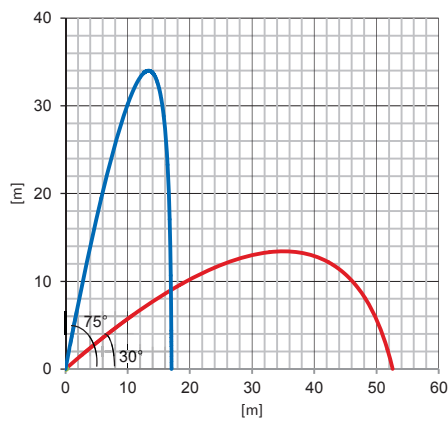

Traiettorie (m), angoli 30° e 75° @ 7 bar
Trajectories (m), angles 30° and 75° @ 7 bar

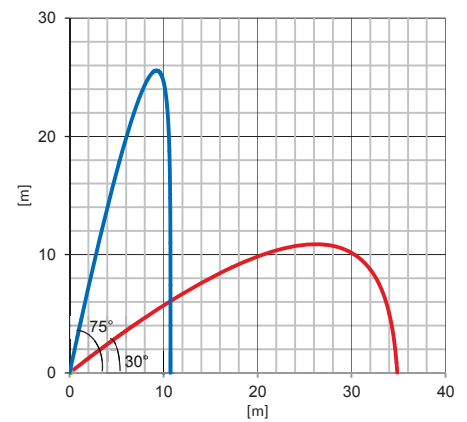

Diagrammi Prestazioni

Performance Diagrams

BNM, BNO, BNE 5500

Pressione (bar) / Portata (L/min)
Pressure (bar) / Flow Rate (lpm)

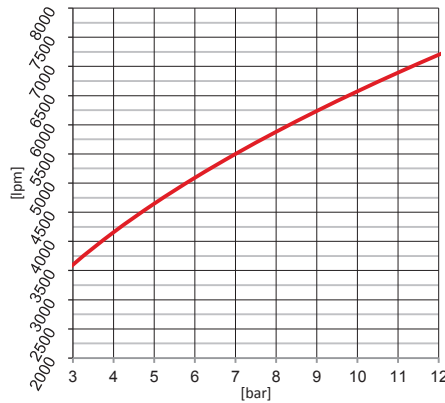

Pressione (bar) / Forza di Reazione (kg)
Pressure (bar) / Reaction Force (kg)

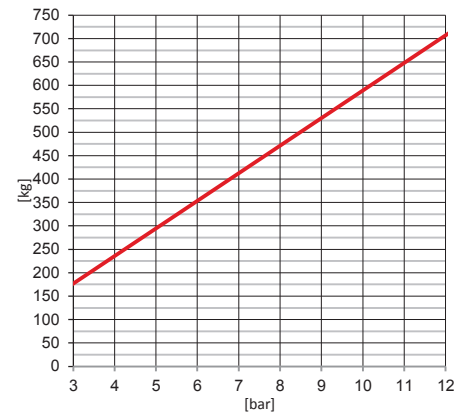

GETTO PIENO / FULL JET

GETTO FRAZIONATO 30° / FOG 30°

GETTO FRAZIONATO 60° / FOG 60°

Pressione (bar) / Gittata (m), angolo 30°
Pressure (bar) / Throw (m), angle 30°

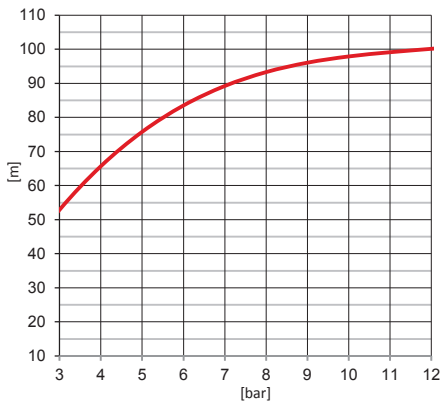

Pressione (bar) / Gittata (m), angolo 30°
Pressure (bar) / Throw (m), angle 30°

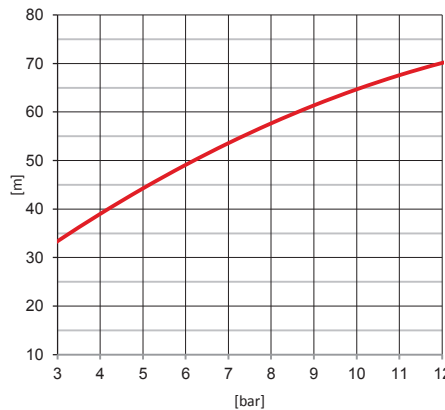

Pressione (bar) / Gittata (m), angolo 30°
Pressure (bar) / Throw (m), angle 30°

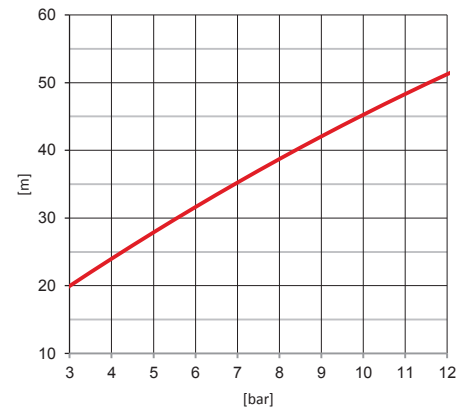

GETTO PIENO / FULL JET

GETTO FRAZIONATO 30° / FOG 30°

GETTO FRAZIONATO 60° / FOG 60°

Traiettorie (m), angoli 30° e 75° @ 7 bar
Trajectories (m), angles 30° and 75° @ 7 bar

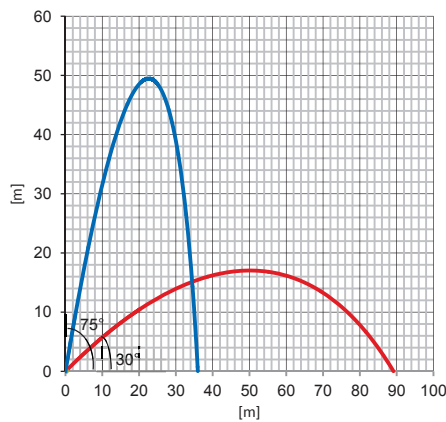

Traiettorie (m), angoli 30° e 75° @ 7 bar
Trajectories (m), angles 30° and 75° @ 7 bar

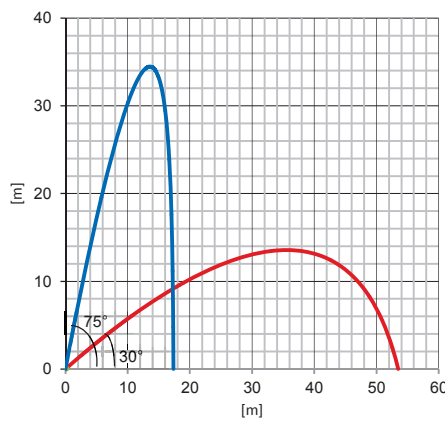

Traiettorie (m), angoli 30° e 75° @ 7 bar
Trajectories (m), angles 30° and 75° @ 7 bar

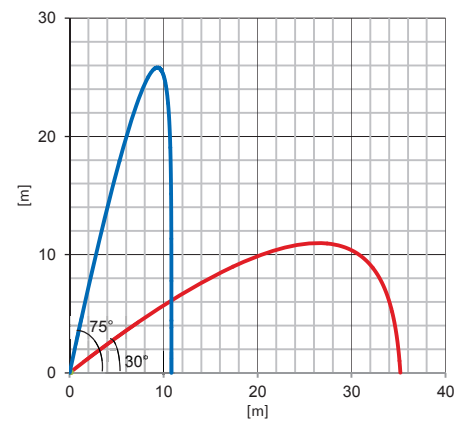

Diagrammi Prestazioni

Performance Diagrams

BNM, BNO, BNE 6000

Pressione (bar) / Portata (L/min)
Pressure (bar) / Flow Rate (lpm)

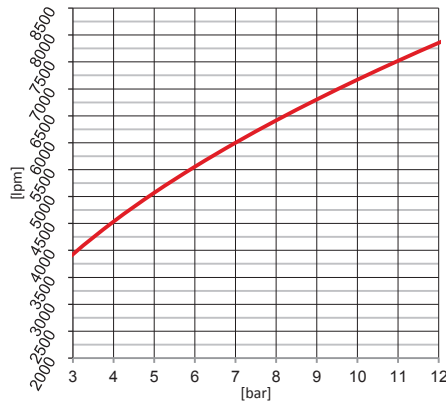

Pressione (bar) / Forza di Reazione (kg)
Pressure (bar) / Reaction Force (kg)

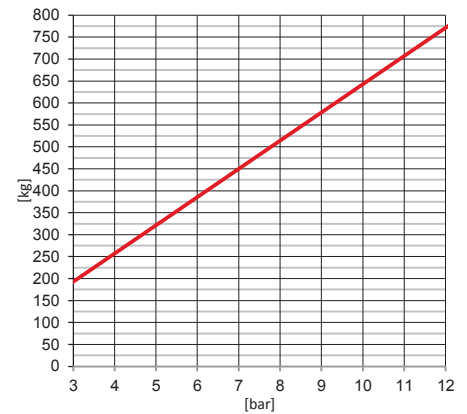

GETTO PIENO / FULL JET

GETTO FRAZIONATO 30° / FOG 30°

GETTO FRAZIONATO 60° / FOG 60°

Pressione (bar) / Gittata (m), angolo 30°
Pressure (bar) / Throw (m), angle 30°

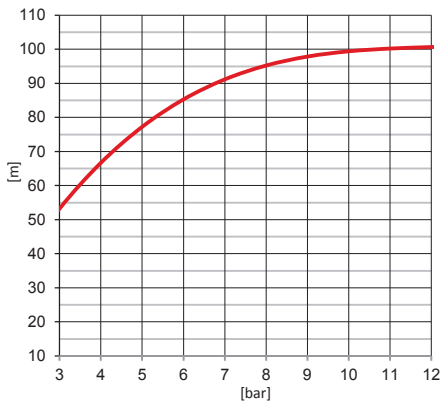

Pressione (bar) / Gittata (m), angolo 30°
Pressure (bar) / Throw (m), angle 30°

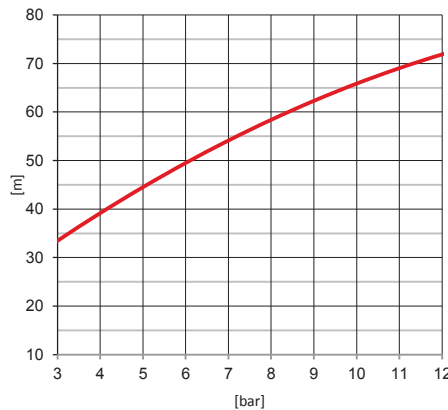

Pressione (bar) / Gittata (m), angolo 30°
Pressure (bar) / Throw (m), angle 30°

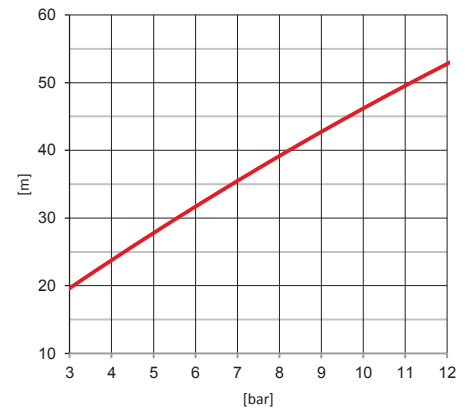

GETTO PIENO / FULL JET

GETTO FRAZIONATO 30° / FOG 30°

GETTO FRAZIONATO 60° / FOG 60°

Traiettorie (m), angoli 30° e 75° @ 7 bar
Trajectories (m), angles 30° and 75° @ 7 bar

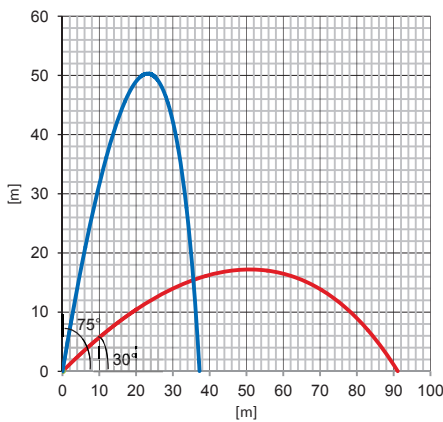

Traiettorie (m), angoli 30° e 75° @ 7 bar
Trajectories (m), angles 30° and 75° @ 7 bar

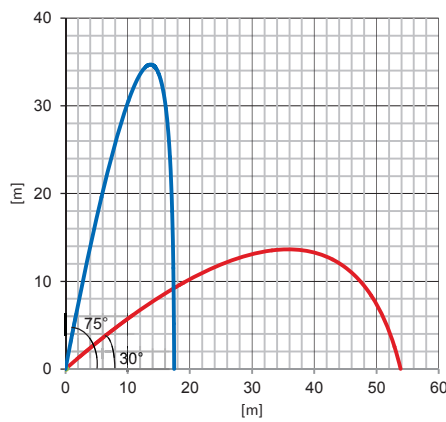

Traiettorie (m), angoli 30° e 75° @ 7 bar
Trajectories (m), angles 30° and 75° @ 7 bar

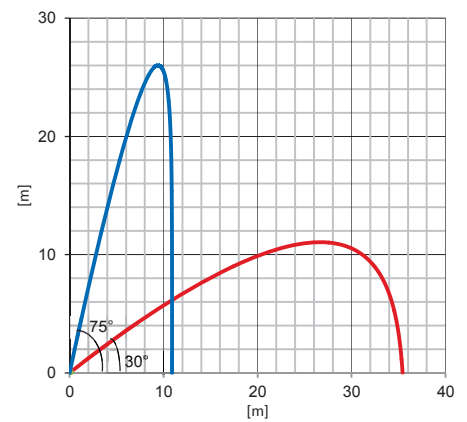

Diagrammi Prestazioni

Performance Diagrams

BNM, BNO, BNE 6500

Pressione (bar) / Portata (L/min)
Pressure (bar) / Flow Rate (lpm)

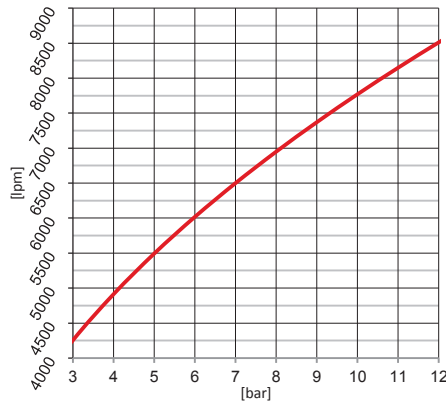

Pressione (bar) / Forza di Reazione (kg)
Pressure (bar) / Reaction Force (kg)

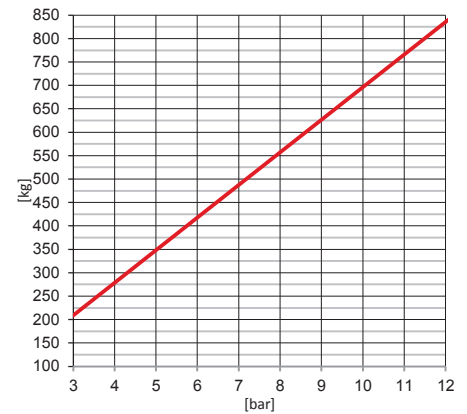

GETTO PIENO / FULL JET

GETTO FRAZIONATO 30° / FOG 30°

GETTO FRAZIONATO 60° / FOG 60°

Pressione (bar) / Gittata (m), angolo 30°
Pressure (bar) / Throw (m), angle 30°

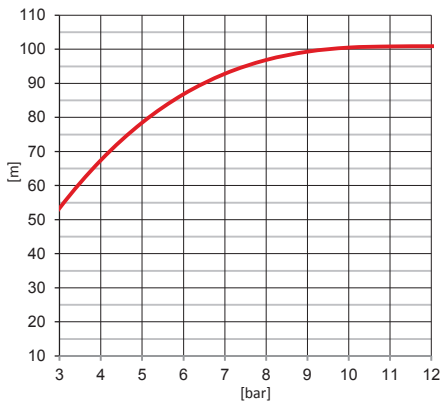

Pressione (bar) / Gittata (m), angolo 30°
Pressure (bar) / Throw (m), angle 30°

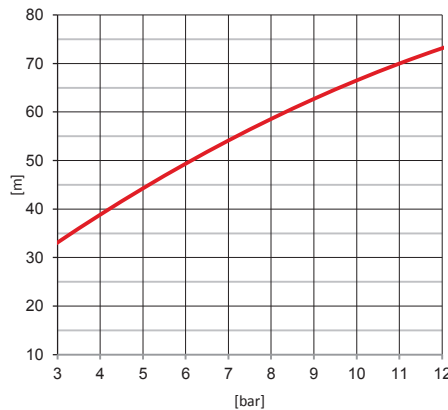

Pressione (bar) / Gittata (m), angolo 30°
Pressure (bar) / Throw (m), angle 30°

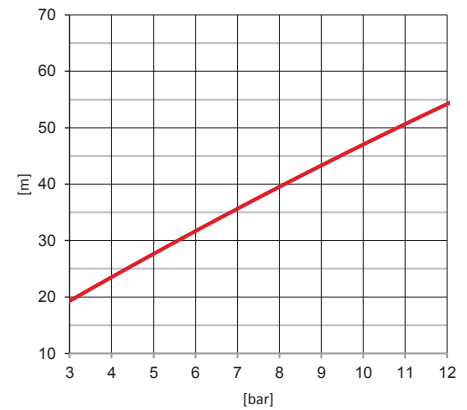

GETTO PIENO / FULL JET

GETTO FRAZIONATO 30° / FOG 30°

GETTO FRAZIONATO 60° / FOG 60°

Traiettorie (m), angoli 30° e 75° @ 7 bar
Trajectories (m), angles 30° and 75° @ 7 bar

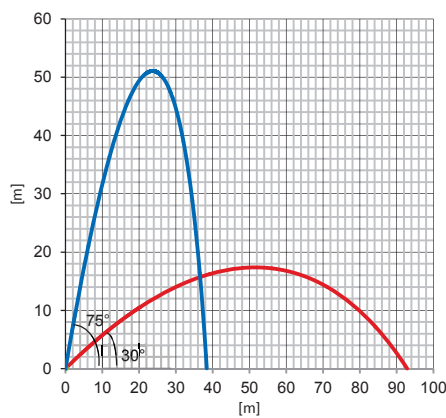

Traiettorie (m), angoli 30° e 75° @ 7 bar
Trajectories (m), angles 30° and 75° @ 7 bar

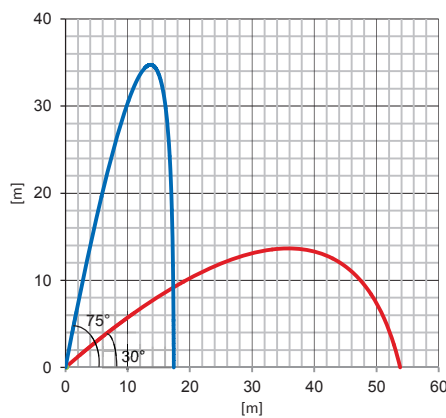

Traiettorie (m), angoli 30° e 75° @ 7 bar
Trajectories (m), angles 30° and 75° @ 7 bar

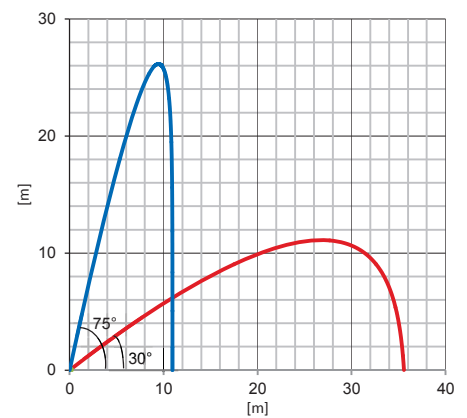

Diagrammi Prestazioni

Performance Diagrams

BNM, BNO, BNE 7000

Pressione (bar) / Portata (L/min)
Pressure (bar) / Flow Rate (lpm)

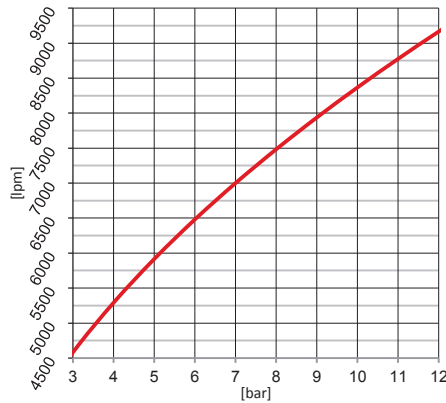

Pressione (bar) / Forza di Reazione (kg)
Pressure (bar) / Reaction Force (kg)

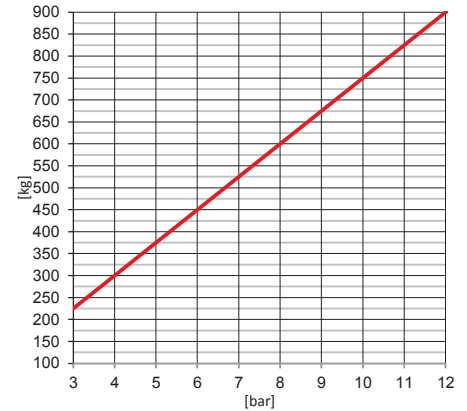

GETTO PIENO / FULL JET

GETTO FRAZIONATO 30° / FOG 30°

GETTO FRAZIONATO 60° / FOG 60°

Pressione (bar) / Gittata (m), angolo 30°
Pressure (bar) / Throw (m), angle 30°

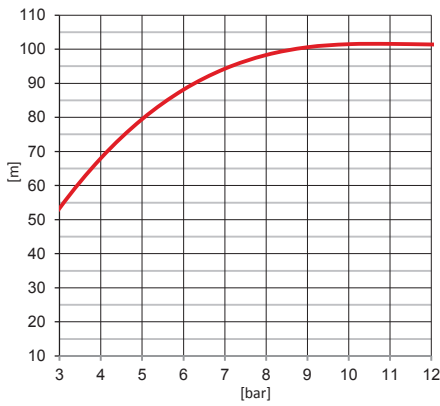

Pressione (bar) / Gittata (m), angolo 30°
Pressure (bar) / Throw (m), angle 30°

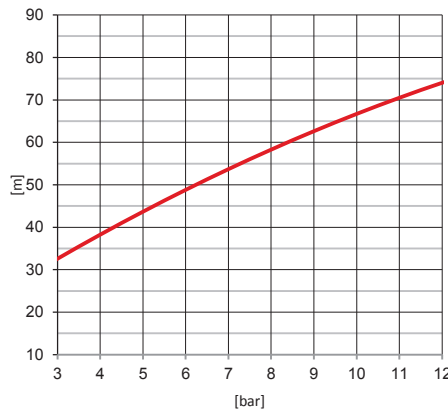

Pressione (bar) / Gittata (m), angolo 30°
Pressure (bar) / Throw (m), angle 30°

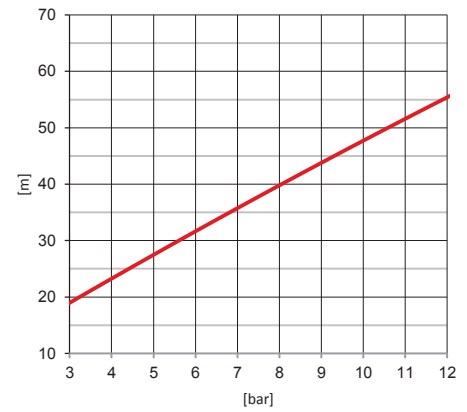

GETTO PIENO / FULL JET

GETTO FRAZIONATO 30° / FOG 30°

GETTO FRAZIONATO 60° / FOG 60°

Traiettorie (m), angoli 30° e 75° @ 7 bar
Trajectories (m), angles 30° and 75° @ 7 bar

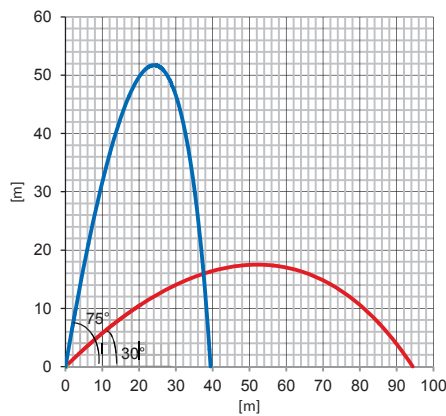

Traiettorie (m), angoli 30° e 75° @ 7 bar
Trajectories (m), angles 30° and 75° @ 7 bar

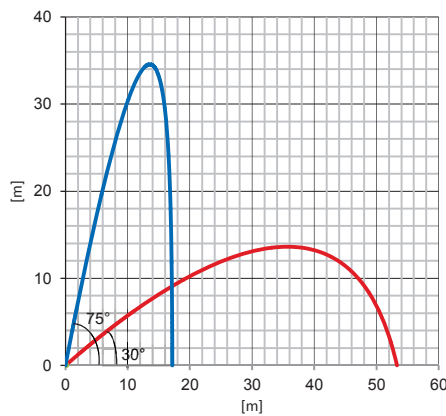

Traiettorie (m), angoli 30° e 75° @ 7 bar
Trajectories (m), angles 30° and 75° @ 7 bar

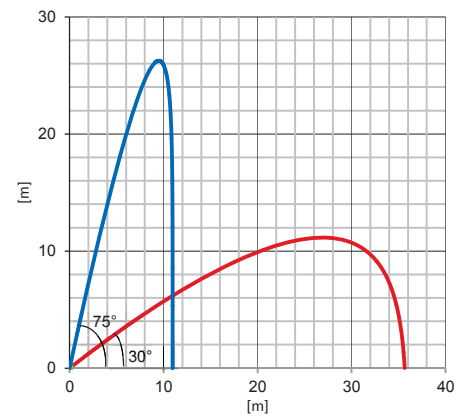

Diagrammi Prestazioni

Performance Diagrams

**BNM, BNO, BNE
7500**

Pressione (bar) / Portata (L/min)
Pressure (bar) / Flow Rate (lpm)

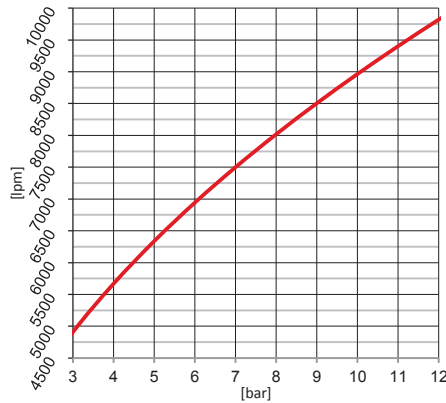

Pressione (bar) / Forza di Reazione (kg)
Pressure (bar) / Reaction Force (kg)

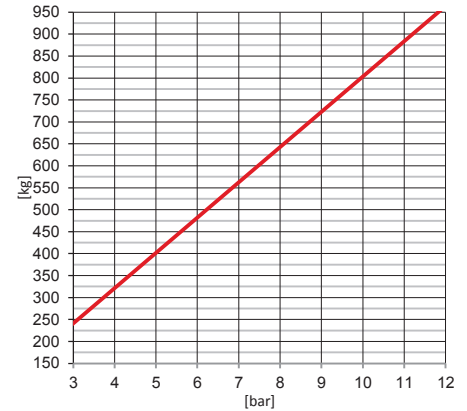

GETTO PIENO / FULL JET

GETTO FRAZIONATO 30° / FOG 30°

GETTO FRAZIONATO 60° / FOG 60°

Pressione (bar) / Gittata (m), angolo 30°
Pressure (bar) / Throw (m), angle 30°

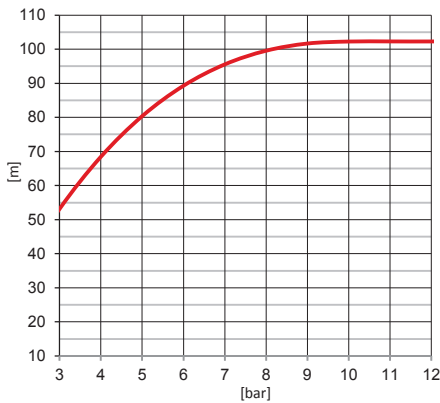

Pressione (bar) / Gittata (m), angolo 30°
Pressure (bar) / Throw (m), angle 30°

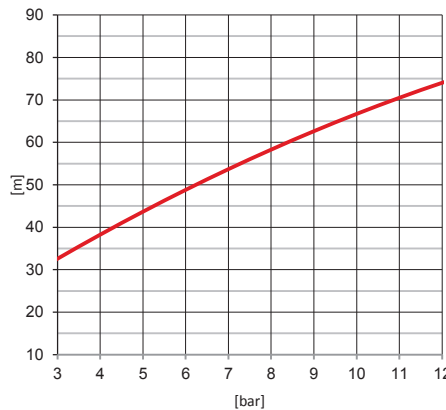

Pressione (bar) / Gittata (m), angolo 30°
Pressure (bar) / Throw (m), angle 30°

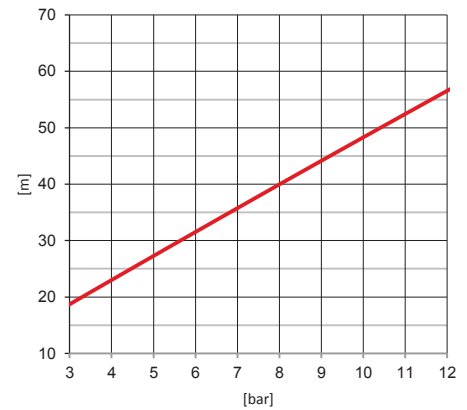

GETTO PIENO / FULL JET

GETTO FRAZIONATO 30° / FOG 30°

GETTO FRAZIONATO 60° / FOG 60°

Traiettorie (m), angoli 30° e 75° @ 7 bar
Trajectories (m), angles 30° and 75° @ 7 bar

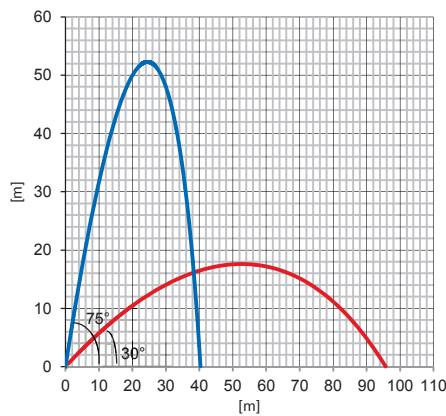

Traiettorie (m), angoli 30° e 75° @ 7 bar
Trajectories (m), angles 30° and 75° @ 7 bar

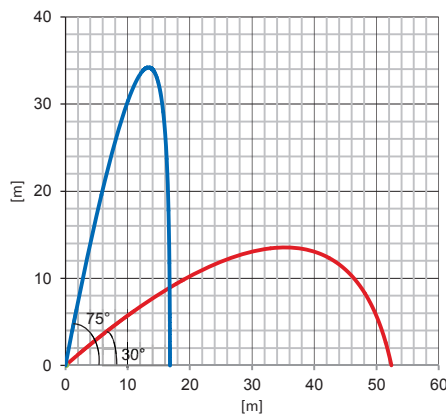

Traiettorie (m), angoli 30° e 75° @ 7 bar
Trajectories (m), angles 30° and 75° @ 7 bar

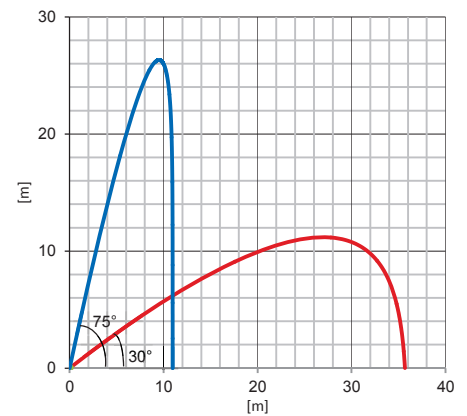

Diagrammi Prestazioni

Performance Diagrams

BNM, BNO, BNE 8000

Pressione (bar) / Portata (L/min)
Pressure (bar) / Flow Rate (lpm)

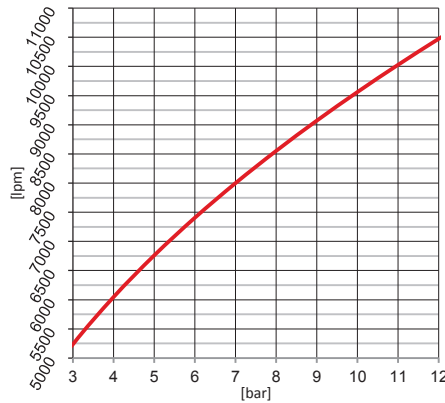

Pressione (bar) / Forza di Reazione (kg)
Pressure (bar) / Reaction Force (kg)

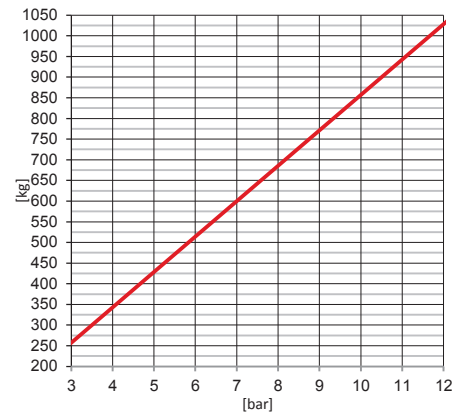

GETTO PIENO / FULL JET

GETTO FRAZIONATO 30° / FOG 30°

GETTO FRAZIONATO 60° / FOG 60°

Pressione (bar) / Gittata (m), angolo 30°
Pressure (bar) / Throw (m), angle 30°

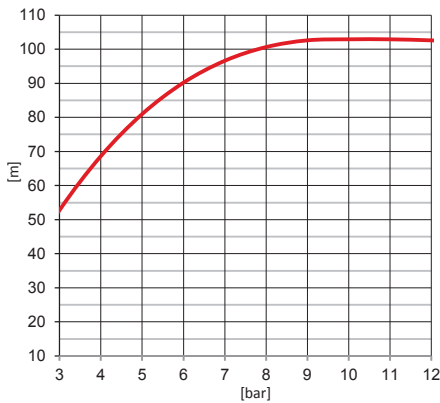

Pressione (bar) / Gittata (m), angolo 30°
Pressure (bar) / Throw (m), angle 30°

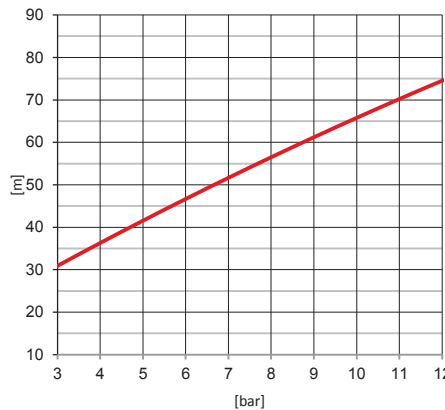

Pressione (bar) / Gittata (m), angolo 30°
Pressure (bar) / Throw (m), angle 30°

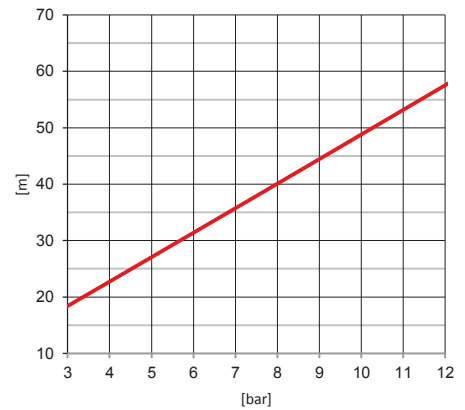

GETTO PIENO / FULL JET

GETTO FRAZIONATO 30° / FOG 30°

GETTO FRAZIONATO 60° / FOG 60°

Traiettorie (m), angoli 30° e 75° @ 7 bar
Trajectories (m), angles 30° and 75° @ 7 bar

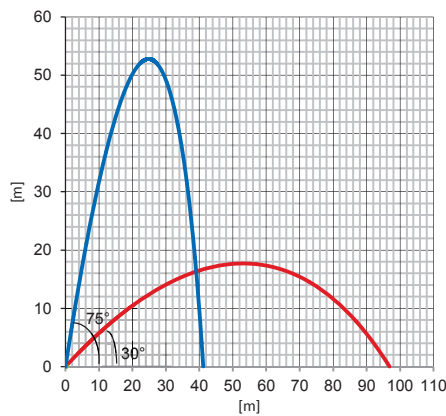

Traiettorie (m), angoli 30° e 75° @ 7 bar
Trajectories (m), angles 30° and 75° @ 7 bar

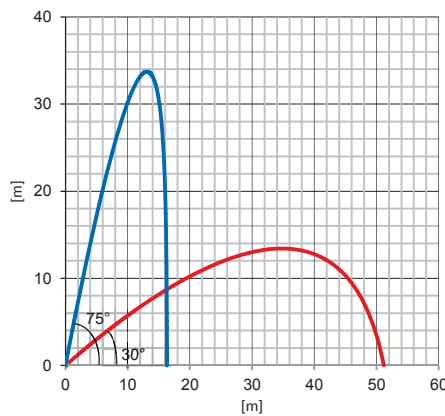

Traiettorie (m), angoli 30° e 75° @ 7 bar
Trajectories (m), angles 30° and 75° @ 7 bar

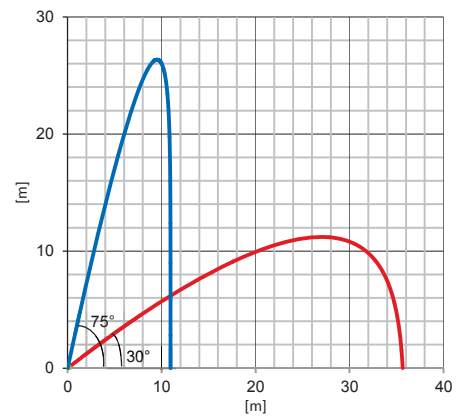

BOCCELLO AUTO-ASPIRANTE – BNA
SELF-INDUCING NOZZLE – BNA



1300 – 2000 lpm



2500 – 4000 lpm

Descrizione

Il bocchello BNA è un dispositivo di regolazione e controllo di flusso che viene montato sui monitori antincendio per generare flussi acqua/schiuma a getto pieno oppure frazionato. Il bocchello è dotato di una gola Venturi capace di aspirare liquido schiumogeno concentrato direttamente da fusti o serbatoi creando la miscela schiumogena direttamente al bocchello. Un regolatore consente di variare la percentuale di miscelazione tra 0, 3 e 6%. Il bocchello può essere manovrato per ottenere getto pieno o getto frazionato agendo sullo scorrimento del corpo superiore su quello inferiore e variando conseguentemente l'angolazione del canale di erogazione. In condizioni di pressione costante, la portata rimane costante ma la geometria del getto varia da getto pieno a getto frazionato. Il bocchello BNA è disponibile con tre attacchi standard diversi: flangia quadra FQ 125, FQ 150 o F.BSP per il collegamento a monitori da 2 ½", 3" e 4". I materiali di costruzione disponibili variano dalle leghe di bronzo all'acciaio Inox rendendo il bocchello versatile ed idoneo per l'impiego con acqua di mare o soluzioni schiumogene all'interno di ambienti industriali ad alta aggressività o in applicazioni offshore. Il bocchello è disponibile con comando di manovra JET/FOG manuale oppure motorizzato con attuatore elettrico o oleodinamico.

Description



The BNA nozzle is a flow pattern regulating device that is installed on firefighting monitors to project flows water/foam in full jet or fog condition. The Nozzle is equipped with a built in Venturi nozzle which is capable to draw liquid concentrate for nearby bulks or tanks and mix it in the nozzle chamber. A regulating valve allow for the settings of mixing proportions between 0, 3 and 6%. The nozzle can be adjusted from full jet to fog stream by varying the nozzle dispersion angle. At constant pressure, the flow rate remains constant but the jet geometry varies from full jet to a fog stream. The BNA nozzle is available with three different connections: square flanged SF125 and SF150 or F.BSP for connection with monitors of 2 ½", 3" and 4". The material of construction available varies from bronze alloys to stainless steel making the nozzle suitable for being used with sea water or water foam solution within industrial harsh environments & offshore applications. The nozzle is available with JET/FOG manual hand levers or with remote controlled actuators either electric or hydraulic.

Caratteristiche tecniche

- Corpo bocchello a scelta tra:
 - Bronzo EN 1982 – CC491K
 - Acciaio inox AISI 316
- Parti interne AISI 316 e ottone
- Leve di comando ottone
- Tubo pescante in PVC con spirale interna d'acciaio, attacco F.G. UNI 25, terminale tubo in PVC, lunghezza 2250 mm
- Valvola d'aspirazione schiumogeno con dispositivo di regolazione percentuale di miscelazione : 0 - 3% - 6%
- Rapporto di espansione 1:4 (Varia con il tipo di schiumogeno)
- Attacco mediante:
 - FQ 125
 - FQ 150
 - F. BSP
- Esecuzione idonea ad installazione esterna in ambiente marino e funzionamento con acqua mare e soluzioni schiumogene
- Pressione di progetto 16 bar

Bocchello con comando idraulico: Versione (BNAO)

- Corpo in acciaio inox AISI 316
- Attuatore oleodinamico in bronzo con leva per il comando di emergenza in AISI 316

Bocchello con attuatore elettrico: Versione 380V ca: (BNAE)

- Movimento getto pieno/nebulizzato mediante riduttore e motore elettrico ATEX II 2G Exd e IIC T4 alimentazione 380V 3F 50 Hz – 0,03 kW – IP 67 dotato di n° 2 limitatori di coppia di sicurezza (uno in apertura e uno in chiusura con contatti NA – NC) e n° 2 interruttori di fine corsa (uno in apertura e uno in chiusura con contatti NA – NC)
- Resistenza anticondensa
- Comando manuale di emergenza per entrambi i movimenti a volantino di sicurezza disinseribile, sempre inserito che non ruota durante la manovra elettrica
- Indicatore meccanico di posizione continuo a quadrante

Bocchello con attuatore elettrico: Versione 220V ca: (BNAE220)

- Movimento getto pieno/nebulizzato mediante attuatore elettrico ATEX II 2 G Exd e IIC T4 alimentazione 230 V 1F 50 Hz – 0,115 Kw – IP 67. Equipaggiato con N° 2 contatti (NA/NC) di massima coppia e N°2 contatti (NA/NC) di fine corsa
- Resistenza anticondensa
- Comando manuale di emergenza per entrambi i movimenti a volantino di sicurezza disinseribile sempre inserito che non ruota durante la manovra elettrica
- Indicatore meccanico di posizione continuo a quadrante

Bocchello con attuatore elettrico: Versione 24V (BNAE24)

Technical characteristics

- Body material to be selected among
 - Bronze EN 1982 – CC491K
 - Stainless Steel AISI 316
- Inner parts in stainless steel AISI 316 and brass
- Brass handgrip
- Dip tube in PVC with internal steel spiral reinforcement, connection UNI 25, rigid terminal tube in PVC, length 2250 mm
- Foam suction valve with mixing ratio selector : 0 - 3% - 6%
- Expansion ratio 1:4 (May vary depending on the foam concentrate)
- Connection:
 - SF 125
 - SF 150
 - F. BSP
- Suitable execution for external installation in marine environment and operation with sea water and foam solutions
- Design pressure: 16 bar

Hydraulic operated nozzle: Version (BNAO)

- Stainless steel AISI 316 body
- Bronze hydraulic actuator with AISI 316 emergency lever

Electrically actuator nozzle: Version 380 V ac: (BNAE)

- Full-Jet/Fog movement driven by geared electric motor ATEX II 2G Exd and IIC T4, supply voltage 380V three-phase 50 Hz – 0.03 kW - IP 67 with 2 safety torque limiters (one for opening and one for closing with NO - NC contacts) and 2 limit switches (one for opening and one for closing with NO - NC contacts)
- Anticondensation resistance
- Emergency manual control by hand wheel with disconnectable safety hand wheel always inserted that does not rotate during electric operation
- Mechanical position gauge

Electrically actuator nozzle: Version 220 V ac: (BNAE220)

- Full-Jet/Fog movement driven by an electric actuator ATEX II 2 G Exd e IIC T4 supply voltage 230 V 1Ph 50 Hz – 0,115 Kw – IP 67. Equipped with N° 2 torque limit contacts (NA/NC) and N°2 limit switch (NA/NC)
- Anti-condensation resistance
- Emergency manual control by hand wheel for both movements with disconnectable safety hand wheel always inserted that does not rotate during electric operation
- Mechanical position gauge

Electrically actuator nozzle: Version 24V (BNAE24)

Caratteristiche tecniche

- Movimento Full-Jet/Fog mediante attuatore elettrico ATEX II 2 G Exd e IIC T4 alimentazione 24 V – 0,14 Kw – IP 67. Equipaggiato con N° 2 contatti (NA/NC) di massima coppia e N°2 contatti (NA/NC) di fine corsa
- Resistenza anticondensa
- Comando manuale di emergenza per entrambi i movimenti a volantino di sicurezza disinseribile sempre inserito che non ruota durante la manovra elettrica
- Indicatore meccanico di posizione continuo a quadrante

Ciclo verniciatura standard SA:

- Pulizia manuale con solvente
- Primer epossidico 60 µm
- Intermedio poliuretano 30 µm
- Finitura poliuretano 30 µm
- Spessore totale film secco 120 µm +/-10%
- Colore rosso RAL 3000

Technical characteristics

- Full-Jet/Fog movement driven by an electric actuator ATEX II 2 G Exd e IIC T4 supply voltage 24 V – 0,14 Kw – IP 67. Equipped with N° 2 torque limit contacts (NA/NC) and N°2 limit switch (NA/NC)
- Anti-condensation resistance
- Emergency manual control by hand wheel for both movements with disconnectable safety hand wheel always inserted that does not rotate during electric operation
- Mechanical position gauge

Painting system standard SA:

- Manual cleaning solvent
- Epoxy primer 60 µm
- Polyurethane intermediate 30 µm
- Polyurethane finish 30 µm
- Total thickness 120 µm dry film +/-10%
- Colour red RAL 3000

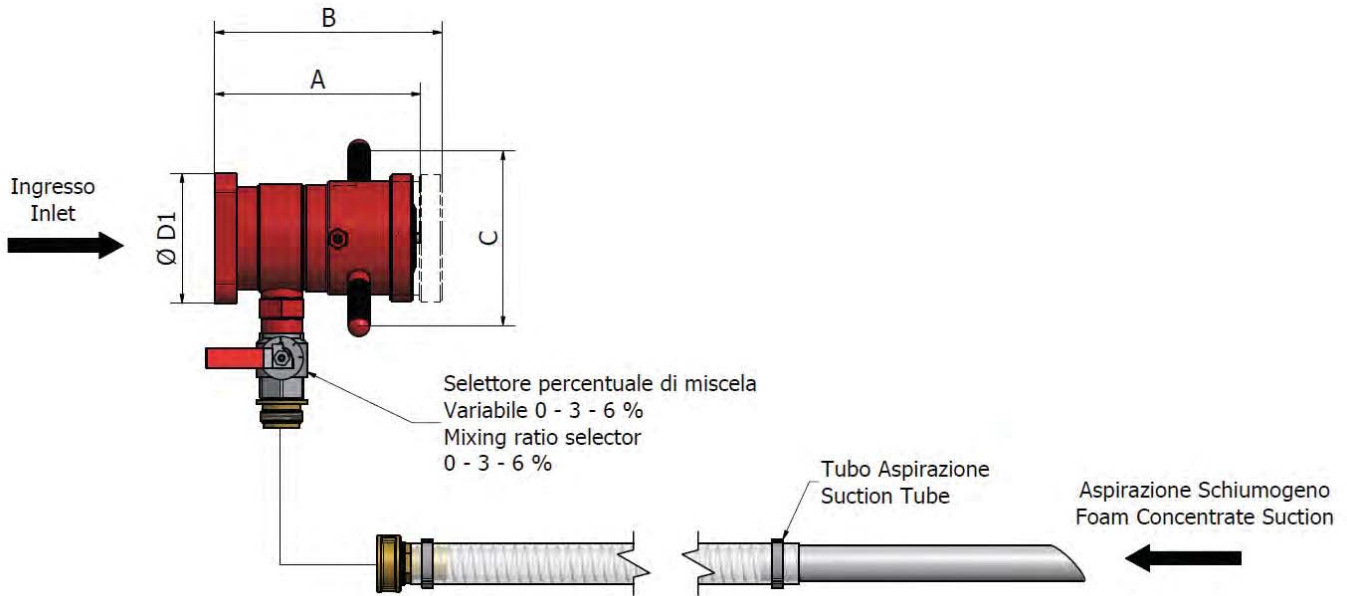

TYPE: 1300 – 2000 lpm

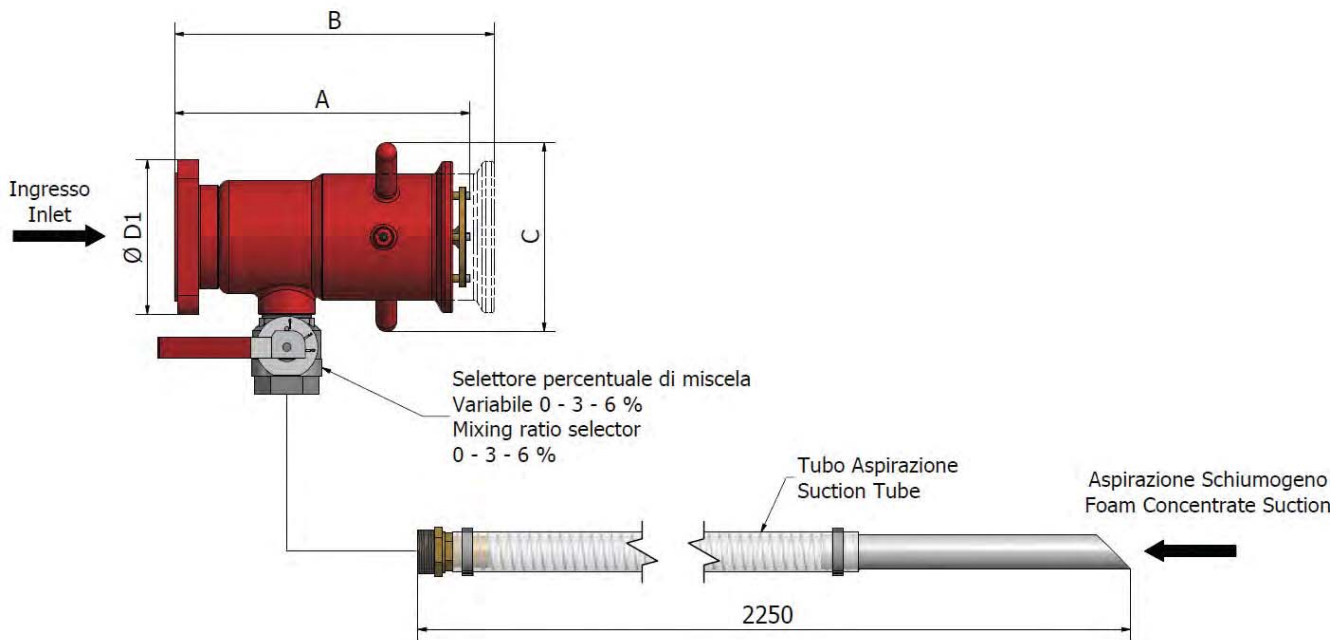

TYPE: 2500 – 4000 lpm

TYPE	Ø D1	A mm (FOG)	B mm (JET)	C mm	Portata Massima (l/min a 7 bar) Max. Flow rate (lpm at 7 bar)							Peso Weight (kg)
					1300	1500	2000	2500	3000	3500	4000	
1300 – 2000 lpm	F.BSP 2 ½"	198	225	235	✓	✓	✓	✗	✗	✗	✗	9,5
	F.BSP 3"	198	225	235	✓	✓	✓	✗	✗	✗	✗	10
	F.BSP 4"	198	225	235	✓	✓	✓	✗	✗	✗	✗	10,5
	FQ125 SF125	185	210	235	✓	✓	✓	✗	✗	✗	✗	10,3
	FQ150 SF150	185	210	235	✓	✓	✓	✗	✗	✗	✗	10,5
2500 – 4000 lpm	F.BSP 3"	314	337	250	✗	✗	✗	✓	✓	✓	✓	16
	F.BSP 4"	314	337	250	✗	✗	✗	✓	✓	✓	✓	16
	FQ125 SF125	287	310	250	✗	✗	✗	✓	✓	✓	✓	15.5
	FQ150 SF150	287	310	250	✗	✗	✗	✓	✓	✓	✓	17

Opzioni

- Ciclo di verniciatura diverso dallo Standard SA
- Tubo di aspirazione lunghezza diversa
- Per ulteriori opzioni o versioni speciali contattare SA Fire Protection

Optional

- Painting system different from Standard SA
- Different length dip tube
- For additional options or special versions contact SA Fire Protection

NOTE
NOTES

CLIENTE / CLIENT:	PROGETTO / PROJECT:	DOC. No.:	REV.:
EMESSO / ISSUED:	CONTROLLATO / CHECKED:	APPROVATO / APPROVED:	
DATA / DATE:	DATA / DATE:	DATA / DATE:	

Diagrammi Prestazioni

Performance Diagrams

**BNAM, BNAO, BNAE
1300**

Pressione (bar) / Portata (L/min)
Pressure (bar) / Flow Rate (lpm)

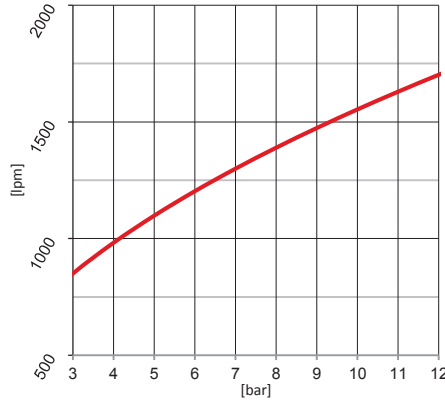

Pressione (bar) / Forza di Reazione (kg)
Pressure (bar) / Reaction Force (kg)

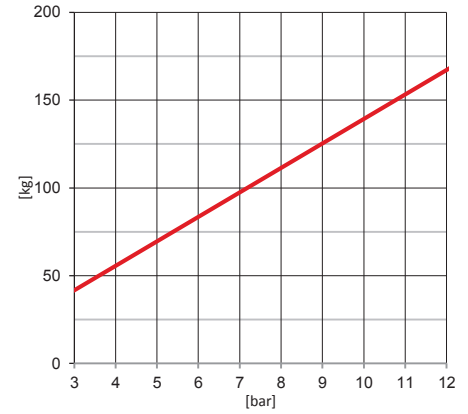

GETTO PIENO / FULL JET

GETTO FRAZIONATO 30° / FOG 30°

GETTO FRAZIONATO 60° / FOG 60°

Pressione (bar) / Gittata (m), angolo 30°
Pressure (bar) / Throw (m), angle 30°

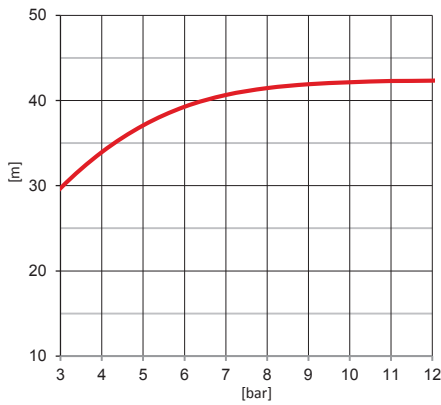

Pressione (bar) / Gittata (m), angolo 30°
Pressure (bar) / Throw (m), angle 30°

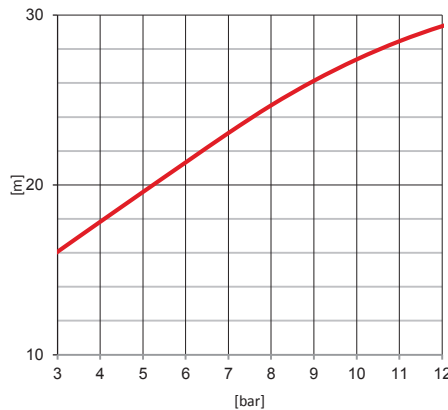

Pressione (bar) / Gittata (m), angolo 30°
Pressure (bar) / Throw (m), angle 30°

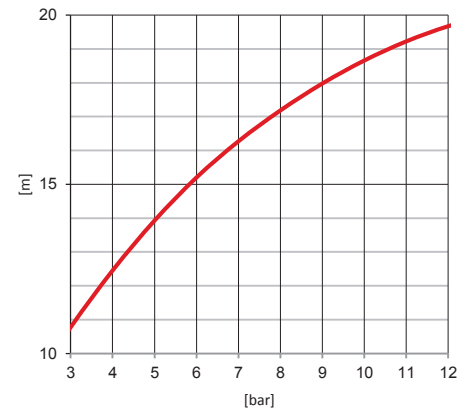

Traiettorie (m), angoli 30° e 75° @ 7 bar
Trajectories (m), angles 30° and 75° @ 7 bar

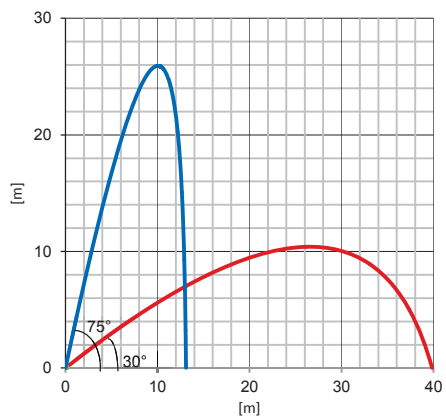

Traiettorie (m), angoli 30° e 75° @ 7 bar
Trajectories (m), angles 30° and 75° @ 7 bar

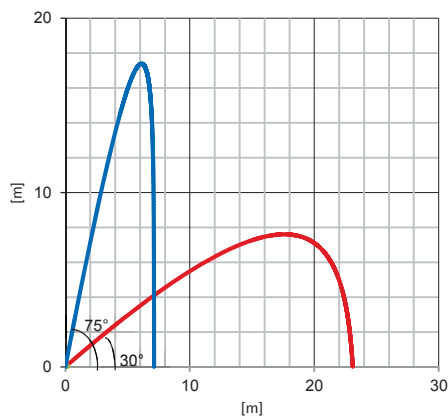

Traiettorie (m), angoli 30° e 75° @ 7 bar
Trajectories (m), angles 30° and 75° @ 7 bar

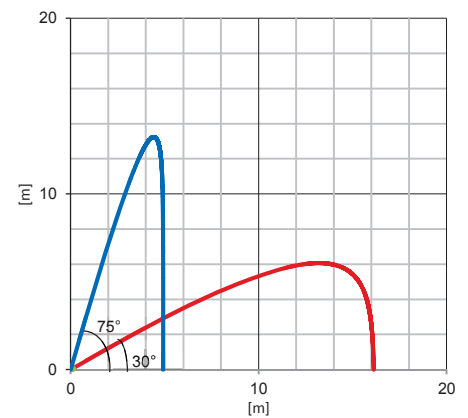

Diagrammi Prestazioni

Performance Diagrams

BNAM, BNAO, BNAE 1500

Pressione (bar) / Portata (L/min)
Pressure (bar) / Flow Rate (lpm)

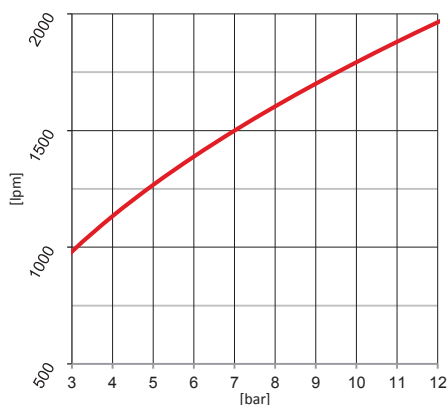

Pressione (bar) / Forza di Reazione (kg)
Pressure (bar) / Reaction Force (kg)

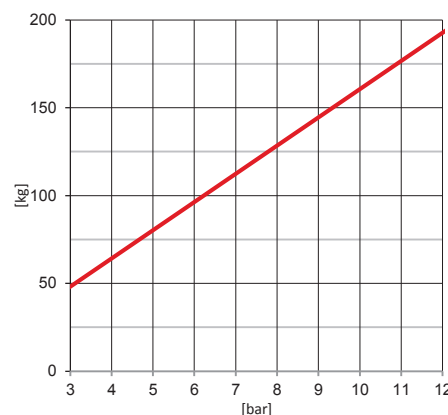

GETTO PIENO / FULL JET

GETTO FRAZIONATO 30° / FOG 30°

GETTO FRAZIONATO 60° / FOG 60°

Pressione (bar) / Gittata (m), angolo 30°
Pressure (bar) / Throw (m), angle 30°

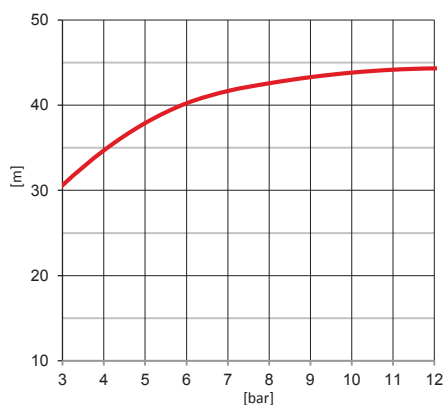

Pressione (bar) / Gittata (m), angolo 30°
Pressure (bar) / Throw (m), angle 30°

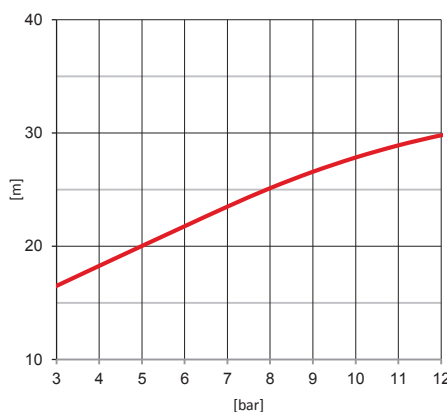

Pressione (bar) / Gittata (m), angolo 30°
Pressure (bar) / Throw (m), angle 30°

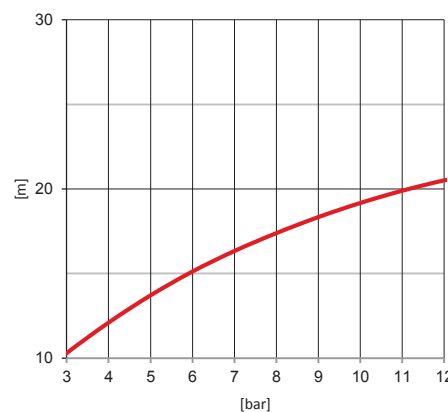

Traiettorie (m), angoli 30° e 75° @ 7 bar
Trajectories (m), angles 30° and 75° @ 7 bar

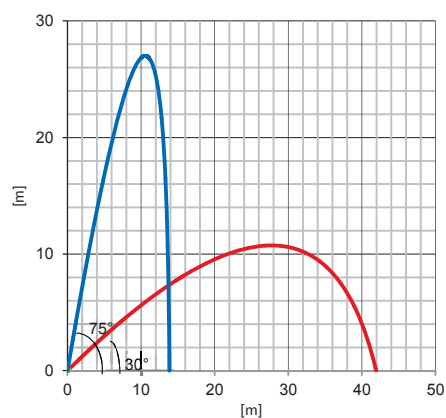

Traiettorie (m), angoli 30° e 75° @ 7 bar
Trajectories (m), angles 30° and 75° @ 7 bar

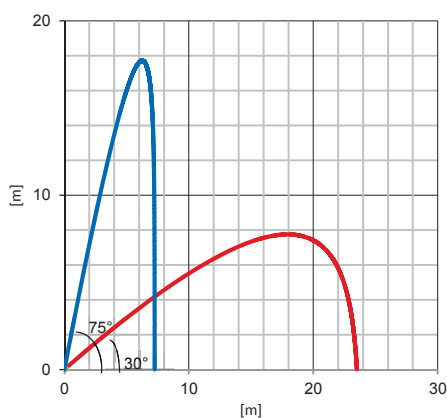

Traiettorie (m), angoli 30° e 75° @ 7 bar
Trajectories (m), angles 30° and 75° @ 7 bar

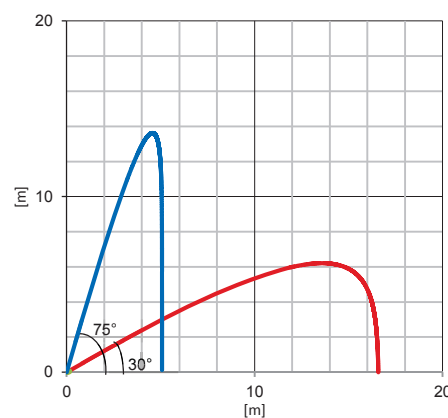

Diagrammi Prestazioni

Performance Diagrams

**BNAM, BNAO, BNAE
2000**

Pressione (bar) / Portata (L/min)
Pressure (bar) / Flow Rate (lpm)

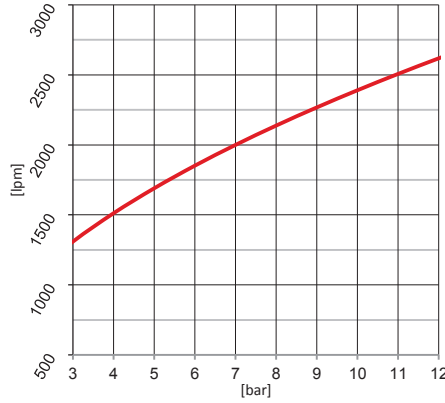

Pressione (bar) / Forza di Reazione (kg)
Pressure (bar) / Reaction Force (kg)

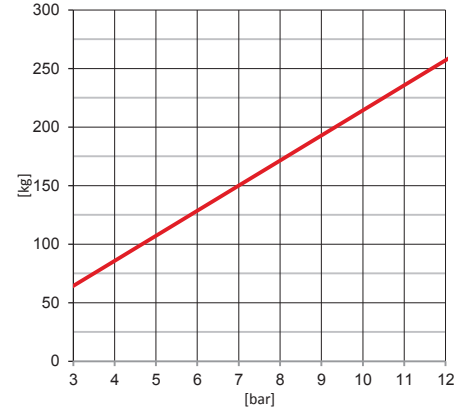

GETTO PIENO / FULL JET

GETTO FRAZIONATO 30° / FOG 30°

GETTO FRAZIONATO 60° / FOG 60°

Pressione (bar) / Gittata (m), angolo 30°
Pressure (bar) / Throw (m), angle 30°

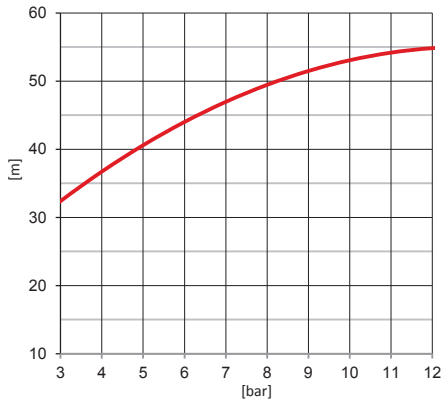

Pressione (bar) / Gittata (m), angolo 30°
Pressure (bar) / Throw (m), angle 30°

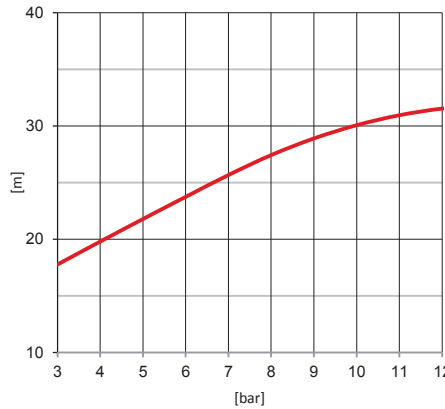

Pressione (bar) / Gittata (m), angolo 30°
Pressure (bar) / Throw (m), angle 30°

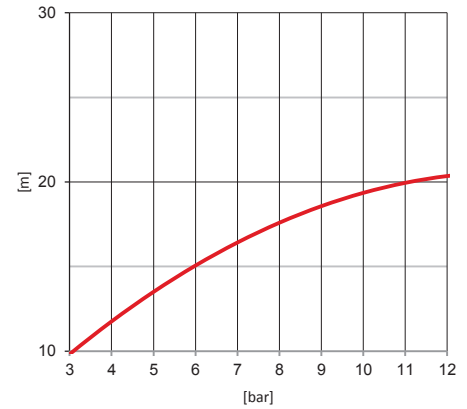

Traiettorie (m), angoli 30° e 75° @ 7 bar
Trajectories (m), angles 30° and 75° @ 7 bar

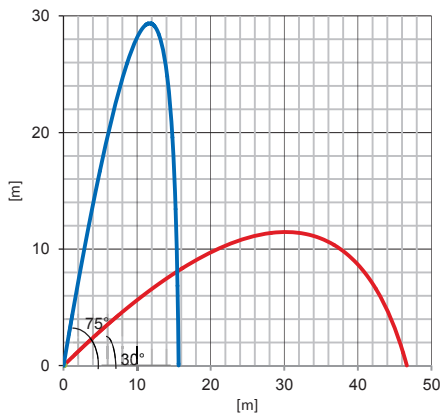

Traiettorie (m), angoli 30° e 75° @ 7 bar
Trajectories (m), angles 30° and 75° @ 7 bar

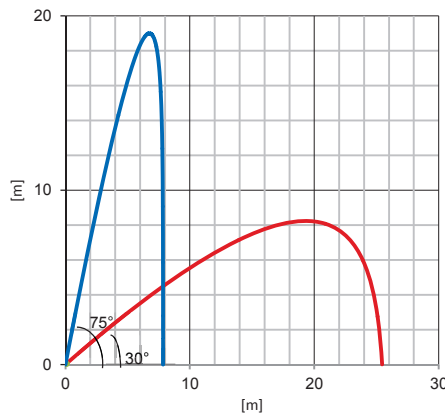

Traiettorie (m), angoli 30° e 75° @ 7 bar
Trajectories (m), angles 30° and 75° @ 7 bar

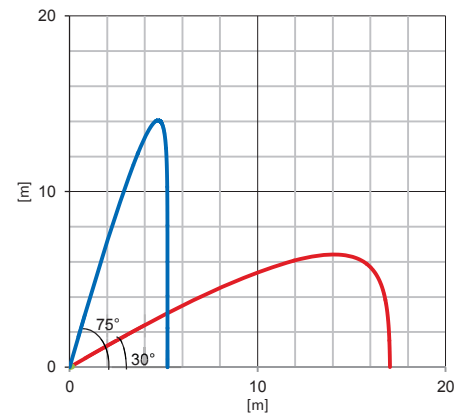

Diagrammi Prestazioni

Performance Diagrams

BNAM, BNAO, BNAE 2500

Pressione (bar) / Portata (L/min)
Pressure (bar) / Flow Rate (lpm)

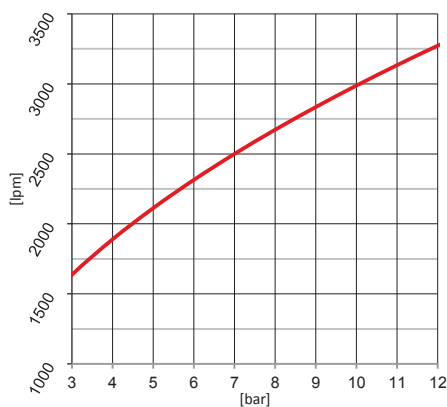

Pressione (bar) / Forza di Reazione (kg)
Pressure (bar) / Reaction Force (kg)

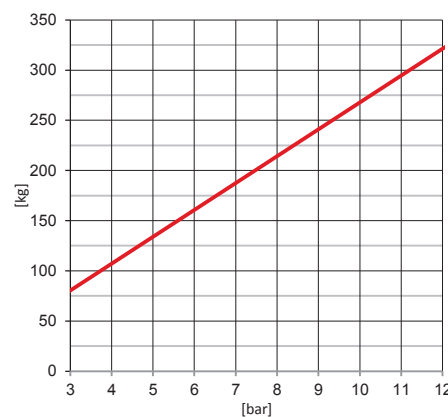

GETTO PIENO / FULL JET

GETTO FRAZIONATO 30° / FOG 30°

GETTO FRAZIONATO 60° / FOG 60°

Pressione (bar) / Gittata (m), angolo 30°
Pressure (bar) / Throw (m), angle 30°

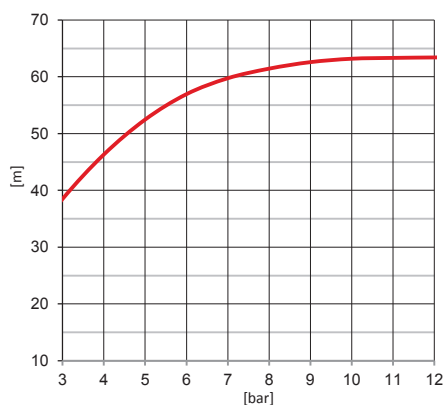

Pressione (bar) / Gittata (m), angolo 30°
Pressure (bar) / Throw (m), angle 30°

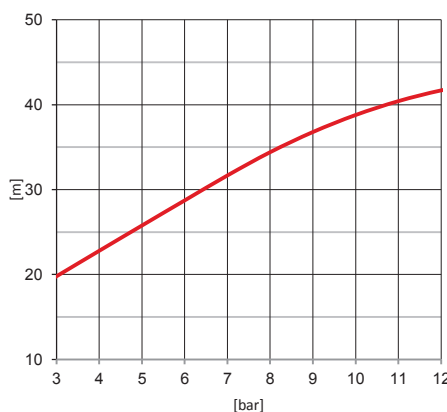

Pressione (bar) / Gittata (m), angolo 30°
Pressure (bar) / Throw (m), angle 30°

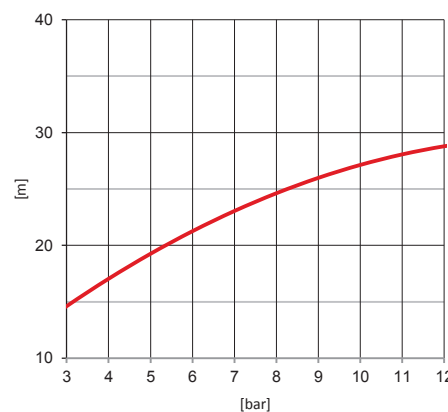

Traiettorie (m), angoli 30° e 75° @ 7 bar
Trajectories (m), angles 30° and 75° @ 7 bar

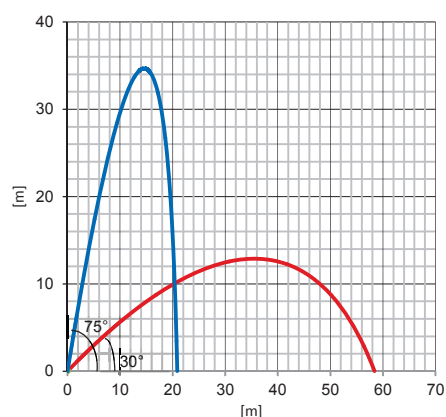

Traiettorie (m), angoli 30° e 75° @ 7 bar
Trajectories (m), angles 30° and 75° @ 7 bar

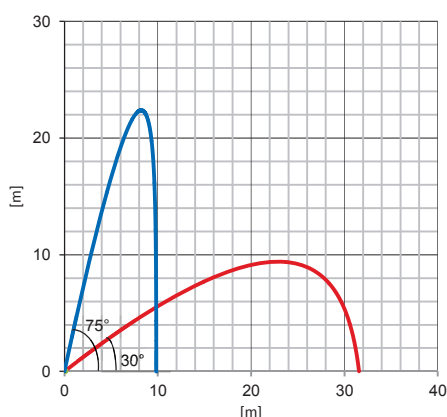

Traiettorie (m), angoli 30° e 75° @ 7 bar
Trajectories (m), angles 30° and 75° @ 7 bar

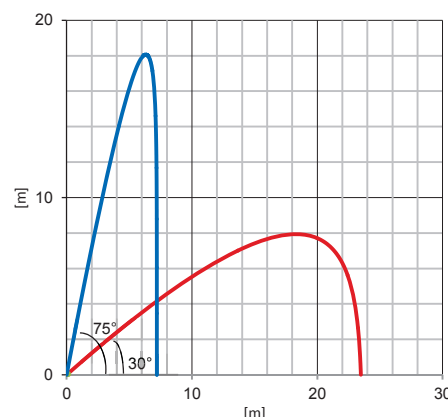

Diagrammi Prestazioni

Performance Diagrams

**BNAM, BNAO, BNAE
3000**

Pressione (bar) / Portata (L/min)
Pressure (bar) / Flow Rate (lpm)

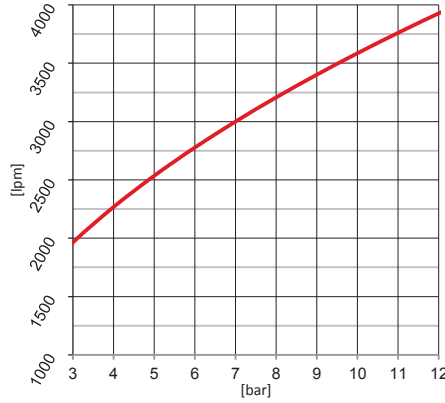

Pressione (bar) / Forza di Reazione (kg)
Pressure (bar) / Reaction Force (kg)

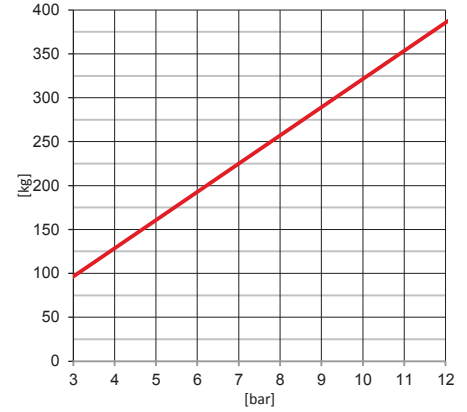

GETTO PIENO / FULL JET

GETTO FRAZIONATO 30° / FOG 30°

GETTO FRAZIONATO 60° / FOG 60°

Pressione (bar) / Gittata (m), angolo 30°
Pressure (bar) / Throw (m), angle 30°

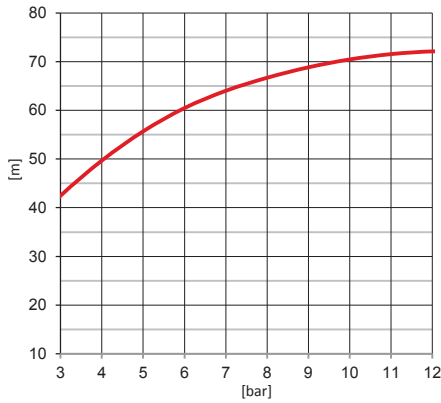

Pressione (bar) / Gittata (m), angolo 30°
Pressure (bar) / Throw (m), angle 30°

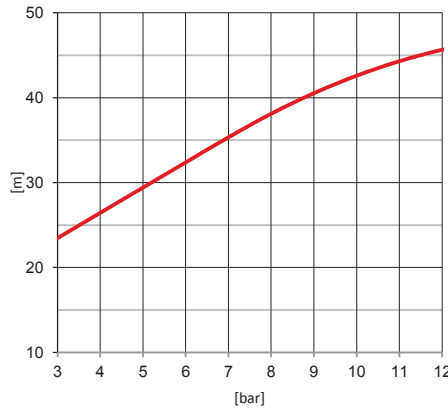

Pressione (bar) / Gittata (m), angolo 30°
Pressure (bar) / Throw (m), angle 30°

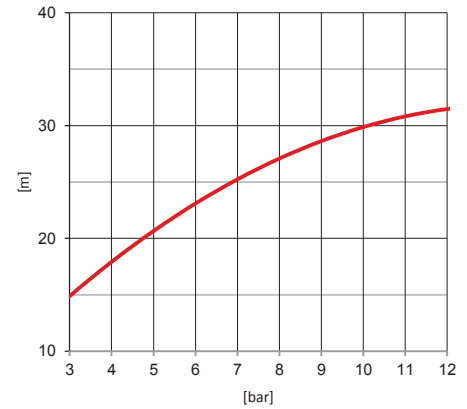

Traiettorie (m), angoli 30° e 75° @ 7 bar
Trajectories (m), angles 30° and 75° @ 7 bar

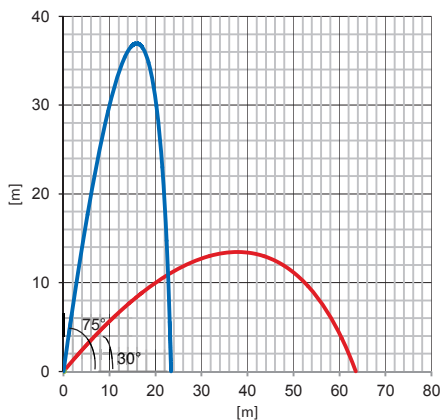

Traiettorie (m), angoli 30° e 75° @ 7 bar
Trajectories (m), angles 30° and 75° @ 7 bar

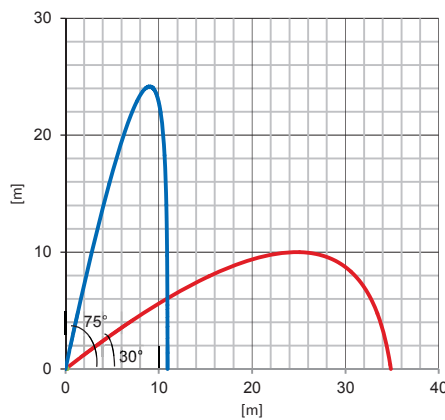

Traiettorie (m), angoli 30° e 75° @ 7 bar
Trajectories (m), angles 30° and 75° @ 7 bar

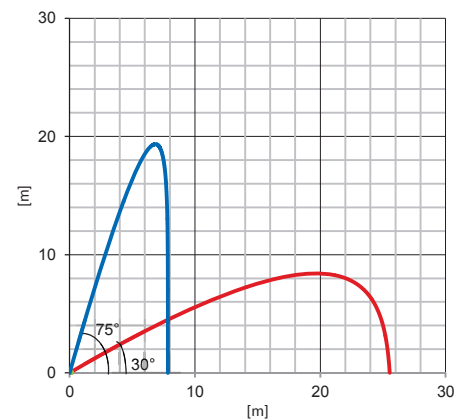

Diagrammi Prestazioni

Performance Diagrams

BNAM, BNAO, BNAE 4000

Pressione (bar) / Portata (L/min)
Pressure (bar) / Flow Rate (lpm)

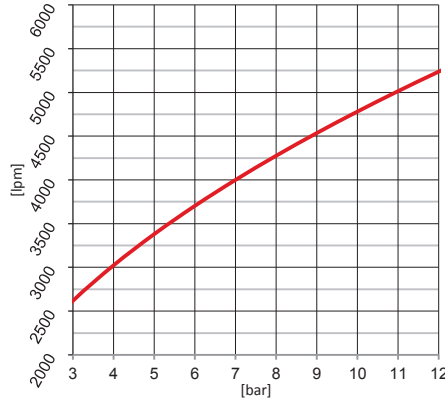

Pressione (bar) / Forza di Reazione (kg)
Pressure (bar) / Reaction Force (kg)

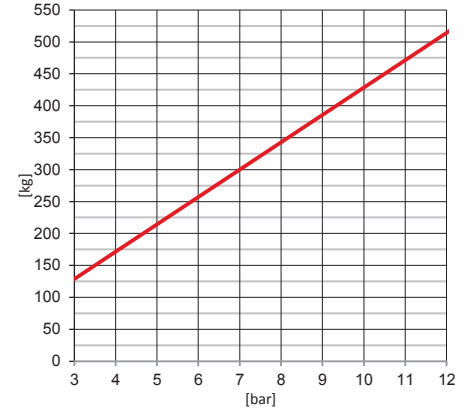

GETTO PIENO / FULL JET

GETTO FRAZIONATO 30° / FOG 30°

GETTO FRAZIONATO 60° / FOG 60°

Pressione (bar) / Gittata (m), angolo 30°
Pressure (bar) / Throw (m), angle 30°

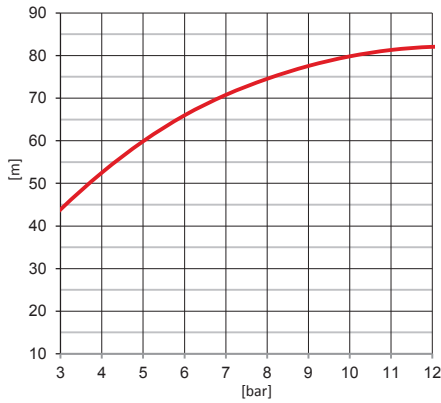

Pressione (bar) / Gittata (m), angolo 30°
Pressure (bar) / Throw (m), angle 30°

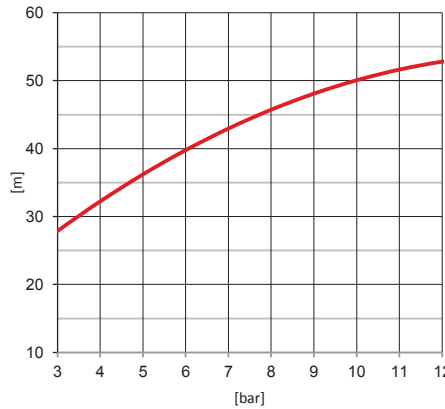

Pressione (bar) / Gittata (m), angolo 30°
Pressure (bar) / Throw (m), angle 30°

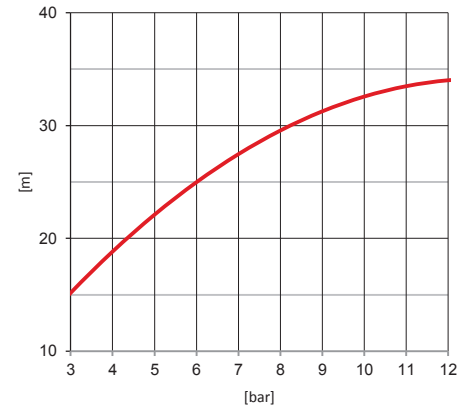

Traiettorie (m), angoli 30° e 75° @ 7 bar
Trajectories (m), angles 30° and 75° @ 7 bar

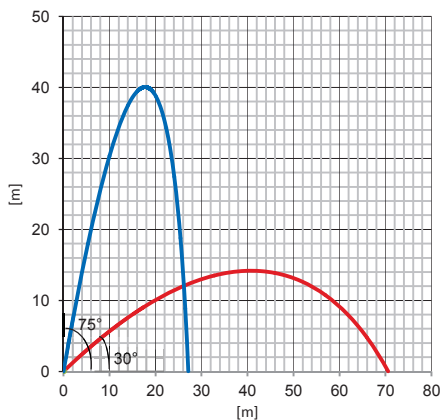

Traiettorie (m), angoli 30° e 75° @ 7 bar
Trajectories (m), angles 30° and 75° @ 7 bar

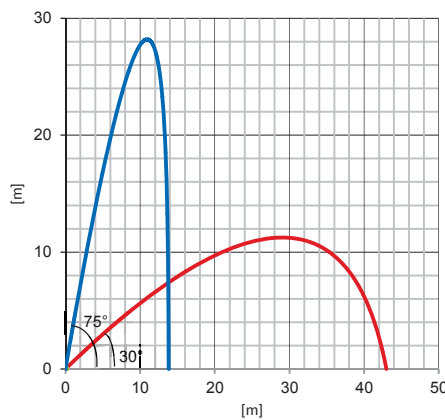

Traiettorie (m), angoli 30° e 75° @ 7 bar
Trajectories (m), angles 30° and 75° @ 7 bar

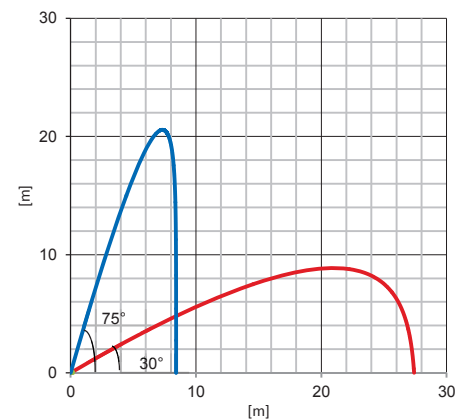

LANCIA SCHIUMA – LS 1000 – 8000 lpm FOAM BRANCHPIPE – LS



Mod. LS



Mod. LSM



Mod. LSO

Descrizione



La lancia schiuma LS a bassa espansione è un dispositivo direzionale che viene montato sui monitor antincendio per proiettare getti di acqua/schiuma su lunghe distanze. La lancia è costruita con un condotto di lancio, dove è installato un ugello capace di generare una pressione negativa al passaggio della miscela. Il getto viene così arricchito dall'aria per inizializzare il processo di emulsificazione della schiuma. La lancia LS è disponibile con tre attacchi standard diversi: flangia quadra FQ 125, FQ 150 o F.BSP per il collegamento a monitori da 2 ½", 3" e 4". Su tutte le lance è possibile montare un deflettore che consente di governare il getto della lancia stessa ottenendo delle distribuzioni a getto aperto. I materiali di costruzione rendono la lancia versatile ed idonea per l'impiego con acqua di mare e soluzioni schiumogene all'interno di ambienti industriali ad alta aggressività o in applicazioni offshore.

Description



The foam branchpipe LS is a low expansion directional discharge device that is installed on firefighting monitors to project flows of foam in full jet condition. The branchpipe is manufactured with a throw tube in which a nozzle is installed. The specific geometry allow for air entrainment into the jet that initiate the emulsification of foam moment before being projected in the air. The LS Branchpipe is available with three different connections: square flanged SF125 and SF150 or F.BSP for connection with monitors of 2 ½", 3" and 4". All branchpipes can be equipped with a spreader which allow to control the discharge from full jet to wide open stream. The material of construction available varies making the nozzle suitable for being used with sea water or water foam solution within industrial harsh environments & offshore applications.

Altre versioni disponibili

- Lancia schiuma Autoaspirante (vedi DS. B.30.30.20.10)

Other versions available

- Self-inducing foam branchpipe (see DS B.30.30.20.10)

Caratteristiche tecniche

Technical characteristics

Lancia

- Corpo in acciaio inox AISI 316
- Corpo ugello a scelta tra:
 - Bronzo EN 1982 – CC491K
 - Acciaio inox AISI 316
 - Lega di alluminio G-AISI9
- Attacco mediante:
 - FQ 125
 - FQ 150
 - F. BSP
- Rapporto di espansione 1:4 (Varia con il tipo di schiumogeno)
- Esecuzione idonea ad installazione esterna in ambiente marino e funzionamento con acqua mare e soluzioni schiumogene
- Pressione di progetto 16 bar

Deflettore con attuatore manuale (LSM)

- Corpo in acciaio inox AISI 316
- Attuatore manuale e tirante in AISI 316

Deflettore con attuatore elettrico (LSE)

- Corpo in acciaio inox AISI 316
- Movimento getto pieno/nebulizzato realizzato mediante riduttore comandato da motore elettrico dotato di n° 2 limitatori di coppia di sicurezza (uno in apertura e uno in chiusura con contatti NA – NC) e n° 2 interruttori di fine corsa (uno in apertura e uno in chiusura con contatti NA –NC)
- Attuatore elettrico alimentazione 24 Vdc – IP 65 per il controllo del deflettore
- Resistenza anticondensa
- Comando manuale di emergenza per entrambi i movimenti a volantino di sicurezza disinseribile sempre inserito che non ruota durante la manovra elettrica
- Indicatore meccanico di posizione continuo a quadrante

Deflettore con attuatore oleodinamico (LSO)

- Corpo in acciaio inox AISI 316
- Attuatore oleodinamico in bronzo con leva per il comando di emergenza in AISI 316

Branchpipe

- Body in Stainless Steel AISI 316
- Nozzle body material to be selected among:
 - Bronze EN 1982 – CC491K
 - Stainless steel AISI 316
 - Aluminium alloy G-AISI9
- Connection:
 - SF 125
 - SF 150
 - F.BSP
- Expansion ratio 1:4 (May vary depending on the foam concentrate)
- Suitable execution for external installation in marine environment and operation with sea water and foam solutions
- Design pressure: 16 bar

Manual actuator Spreaders (LSM)

- Stainless steel AISI 316 body
- Stainless steel AISI 316 manual actuator and lever

Electrically actuator Spreaders (LSE)

- Stainless steel AISI 316 body
- Full-flow/atomizing movement driven by geared electric motor with 2 safety torque limiters (one for opening and one for closing with NO - NC contacts) and 2 limit switches (one for opening and one for closing with NO -NC contacts)
- Electric actuator, supply voltage 24 Vdc – IP65 for spreaders control.
- Anti-condensation resistance
- Emergency manual control by hand wheel for both movements with disconnectable safety hand wheel always inserted that does not rotate during electric operation
- Mechanical position gauge

Hydraulic actuator Spreaders (LSO)

- Stainless steel AISI 316 body
- Bronze hydraulic actuator with AISI 316 emergency lever

Caratteristiche tecniche

Ciclo verniciatura standard SA:

Lancia

- Pulizia manuale con solvente
- Primer epossidico 60 µm
- Finitura poliuretano 60 µm
- Spessore totale film secco 120 µm +/-10%
- Colore bianco RAL 9010

Attuatore manuale

- Finitura al naturale

Attuatore elettrico

- Colore rosso RAL 3000

Attuatore oleodinamico

- Colore rosso RAL 3000

Technical characteristics

Painting system standard SA:

Branchpipe

- Manual cleaning solvent
- Epoxy primer 60 µm
- Polyurethane finish 60 µm
- Total thickness 120 µm dry film +/-10%
- Colour white RAL 9010

Manual actuator

- Natural finishing

Electrical actuator

- Colour red RAL 3000

Hydraulically actuator

- Colour red RAL 3000

Dimensioni e Pesì

Dimensions and Weights

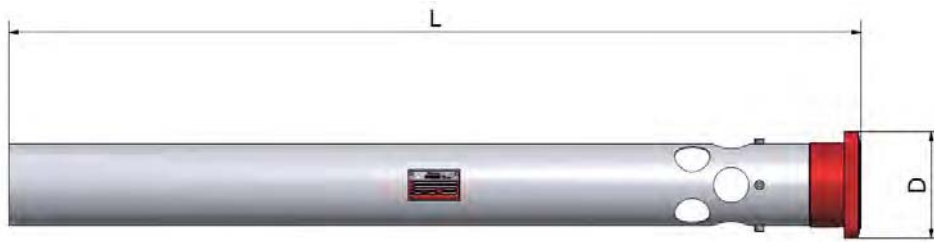

D	L mm	Portata (l/min a 7 bar) Flow rate (lpm at 7 bar)											Peso Weight (kg)
		1000	1500	2000	2500	3000	3500	4000	5000	6000	7000	8000	
FQ125 SF125	1200	✓	✓	✓	✓	✗	✗	✗	✗	✗	✗	✗	9
	1500	✗	✗	✗	✗	✓	✓	✗	✗	✗	✗	✗	12
	1600	✗	✗	✗	✗	✗	✗	✓	✗	✗	✗	✗	13
FQ150 SF150	1200	✓	✓	✓	✓	✗	✗	✗	✗	✗	✗	✗	10
	1500	✗	✗	✗	✗	✓	✓	✗	✗	✗	✗	✗	14
	1600	✗	✗	✗	✗	✗	✗	✓	✓	✓	✓	✓	15
F.BSP 2 1/2"	1200	✓	✓	✓	✗	✗	✗	✗	✗	✗	✗	✗	9
F.BSP 3"	1200	✓	✓	✓	✓	✗	✗	✗	✗	✗	✗	✗	10
	1500	✗	✗	✗	✗	✓	✓	✗	✗	✗	✗	✗	10
	1600	✗	✗	✗	✗	✗	✗	✓	✗	✗	✗	✗	12
F.BSP 4"	1200	✓	✓	✓	✓	✗	✗	✗	✗	✗	✗	✗	10
	1500	✗	✗	✗	✗	✓	✓	✗	✗	✗	✗	✗	10
	1600	✗	✗	✗	✗	✗	✗	✓	✓	✓	✓	✓	15

Opzioni

- Ciclo di verniciatura diverso dallo Standard SA
- Per ulteriori opzioni o versioni speciali contattare SA Fire Protection

Optional

- Painting system different from Standard SA
- For additional options or special versions contact SA Fire Protection

Codice Identificativo
Identification Form

OPZIONI / OPTIONS

Mod.

/ / / /

1
2
3
4
5

Quantità / Quantity

LANCIA SCHIUMA LS / FOAM BRANCHPIPE LS

LANCIA SCHIUMA LS / FOAM BRANCHPIPE LS					
CORPO BODY	1	Tipologia Type	Lancia schiuma Foam branchpipe	LS <input type="checkbox"/>	
			Lancia schiuma con deflettore manuale Foam branchpipe with manual spreader	LSM <input type="checkbox"/>	
			Lancia schiuma con deflettore elettrico Foam branchpipe with electric spreader	LSE <input type="checkbox"/>	
			Lancia schiuma con deflettore oleodinamico Foam branchpipe with hydraulic spreader	LSO <input type="checkbox"/>	
UGELLO NOZZLE	2	Materiale Material	Bronzo EN 1982 – CC491K Bronze EN 1982 – CC491K	CBG10 <input type="checkbox"/>	
			Acciaio inox AISI 316 Stainless steel AISI 316	CAI12 <input type="checkbox"/>	
			Lega di alluminio G-AISI9 Aluminium alloy G-AISI9	CAL10 <input type="checkbox"/>	Materiale standard Standard material
FLANGIA FLANGE	3	Dimensione Size	FQ 125 SF 125	125 <input type="checkbox"/>	
			FQ 150 SF 150	150 <input type="checkbox"/>	
			F. BSP 2 ½"	2M <input type="checkbox"/>	
			F. BSP 3"	3 <input type="checkbox"/>	
			F. BSP 4"	4 <input type="checkbox"/>	
PORTATA FLOW RATE	4	Portata a 7 bar Flow rate at 7 bar	1000 l/min	10 <input type="checkbox"/>	
			1500 l/min	15 <input type="checkbox"/>	
			2000 l/min	20 <input type="checkbox"/>	
			2500 l/min	25 <input type="checkbox"/>	
			3000 l/min	30 <input type="checkbox"/>	
			3500 l/min	35 <input type="checkbox"/>	
			4000 l/min	40 <input type="checkbox"/>	
			5000 l/min	50 <input type="checkbox"/>	
			6000 l/min	60 <input type="checkbox"/>	
			7000 l/min	70 <input type="checkbox"/>	
			8000 l/min	80 <input type="checkbox"/>	
			Altro Other	F <input type="checkbox"/>	Specificare in Note la portata richiesta. Specify in Notes the flow rate required.
OPZIONI OPTIONS	5	Verniciatura Painting	Verniciatura diversa da ciclo SA standard Painting system different for SA standard	C <input type="checkbox"/>	Specificare in Note il ciclo di verniciatura richiesto. Specify in Notes the painting procedure required.

NOTE
NOTES

CLIENTE / CLIENT:	PROGETTO / PROJECT:	DOC. No.:	REV.:
EMESSO / ISSUED:	CONTROLLATO / CHECKED:	APPROVATO / APPROVED:	
DATA / DATE:	DATA / DATE:	DATA / DATE:	

LS-10	Diagrammi Prestazioni Performance Diagrams	LS-15
	<p>Pressione (bar) / Portata (l/min) Pressure (bar) / Flow Rate (lpm)</p>	
	<p>Pressione (bar) / Forza di Reazione (kg) Pressure (bar) / Reaction Force (kg)</p>	
	<p>Pressione (bar) / Gittata (m), angolo 30° Pressure (bar) / Throw (m), angle 30°</p>	
	<p>Traiettorie (m), angoli 30° e 75° @ 7 bar Trajectories (m), angles 30° and 75° @ 7 bar</p>	

LS-20	Diagrammi Prestazioni Performance Diagrams	LS-25
	<p>Pressione (bar) / Portata (l/min) Pressure (bar) / Flow Rate (lpm)</p>	
	<p>Pressione (bar) / Forza di Reazione (kg) Pressure (bar) / Reaction Force (kg)</p>	
	<p>Pressione (bar) / Gittata (m), angolo 30° Pressure (bar) / Throw (m), angle 30°</p>	
	<p>Traiettorie (m), angoli 30° e 75° @ 7 bar Trajectories (m), angles 30° and 75° @ 7 bar</p>	

LS-30	Diagrammi Prestazioni Performance Diagrams	LS-35
	<p>Pressione (bar) / Portata (l/min) Pressure (bar) / Flow Rate (lpm)</p>	
	<p>Pressione (bar) / Forza di Reazione (kg) Pressure (bar) / Reaction Force (kg)</p>	
	<p>Pressione (bar) / Gittata (m), angolo 30° Pressure (bar) / Throw (m), angle 30°</p>	
	<p>Traiettorie (m), angoli 30° e 75° @ 7 bar Trajectories (m), angles 30° and 75° @ 7 bar</p>	

LS-40	Diagrammi Prestazioni Performance Diagrams	LS-50
	<p>Pressione (bar) / Portata (l/min) Pressure (bar) / Flow Rate (lpm)</p>	
	<p>Pressione (bar) / Forza di Reazione (kg) Pressure (bar) / Reaction Force (kg)</p>	
	<p>Pressione (bar) / Gittata (m), angolo 30° Pressure (bar) / Throw (m), angle 30°</p>	
	<p>Traiettorie (m), angoli 30° e 75° @ 7 bar Trajectories (m), angles 30° and 75° @ 7 bar</p>	

LS-60	Diagrammi Prestazioni Performance Diagrams	LS-70
	<p>Pressione (bar) / Portata (l/min) Pressure (bar) / Flow Rate (lpm)</p>	
	<p>Pressione (bar) / Forza di Reazione (kg) Pressure (bar) / Reaction Force (kg)</p>	
	<p>Pressione (bar) / Gittata (m), angolo 30° Pressure (bar) / Throw (m), angle 30°</p>	
	<p>Traiettorie (m), angoli 30° e 75° @ 7 bar Trajectories (m), angles 30° and 75° @ 7 bar</p>	

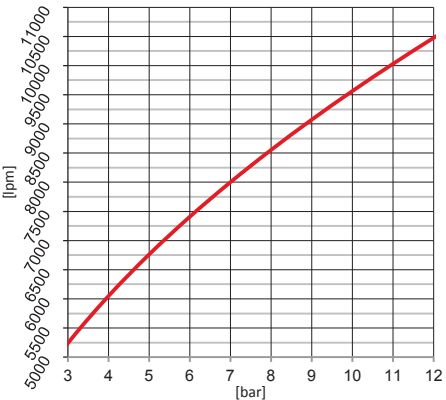
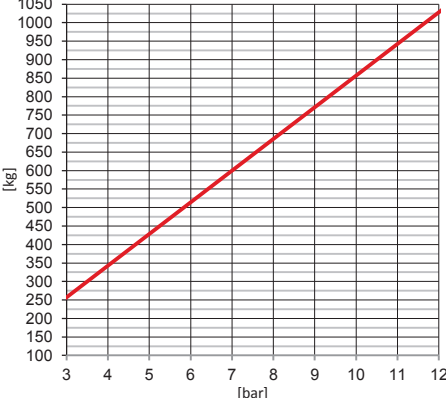
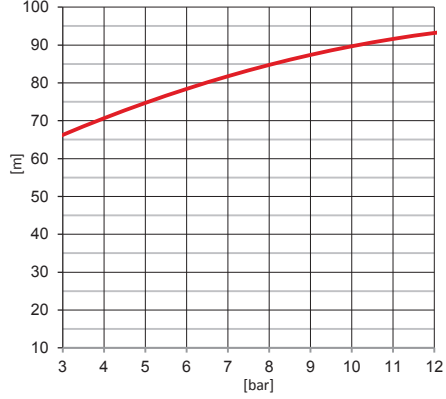
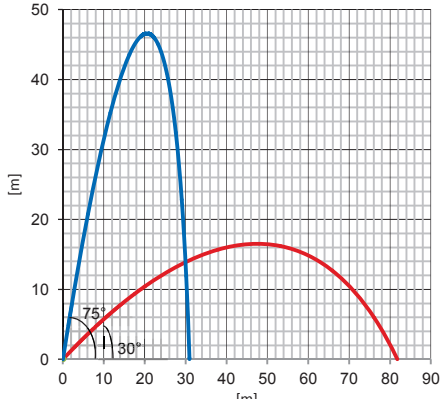
LS-80	Diagrammi Prestazioni Performance Diagrams	-
	<p>Pressione (bar) / Portata (l/min) Pressure (bar) / Flow Rate (lpm)</p>	-
	<p>Pressione (bar) / Forza di Reazione (kg) Pressure (bar) / Reaction Force (kg)</p>	-
	<p>Pressione (bar) / Gittata (m), angolo 30° Pressure (bar) / Throw (m), angle 30°</p>	-
	<p>Traiettorie (m), angoli 30° e 75° @ 7 bar Trajectories (m), angles 30° and 75° @ 7 bar</p>	-

LANCIA SCHIUMA – LS 9000 – 15000 lpm FOAM BRANCHPIPE – LS



Mod. LS



Mod. LSM



Mod. LSO

Descrizione



La lancia schiuma LS a bassa espansione è un dispositivo direzionale che viene montato sui monitori antincendio per proiettare getti di acqua/schiuma su lunghe distanze. La lancia è costruita con un condotto di lancio dove è installato un ugello capace di generare una pressione negativa al passaggio della miscela. Il getto viene così arricchito dall'aria per inizializzare il processo di emulsificazione della schiuma. La lancia LS è disponibile con attacco flangiato ANSI 150 in acciaio al carbonio o inox per il collegamento a monitori da 6" ed 8". Su tutte le lance è possibile montare un deflettore che consente di governare il getto della lancia stessa ottenendo delle distribuzioni a getto aperto. I materiali di costruzione rendono la lancia versatile ed idonea per l'impiego con acqua di mare e soluzioni schiumogene all'interno di ambienti industriali ad alta aggressività o in applicazioni offshore.

Description



The foam branchpipe LS is a low expansion directional discharge device that is installed on firefighting monitors to project flows of foam in full jet condition. The branchpipe is manufactured with a throw tube in which a nozzle is installed. The specific geometry allow for air entrainment into the jet that initiate the emulsification of foam moment before being projected in the air. The LS Branchpipe is available with a flanged connection ANSI 150 in carbon steel or stainless steel for connection with monitors of 6" and 8". All branchpipes can be equipped with a spreader which allow to control the discharge from full jet to wide open stream. The material of construction available varies making the nozzle suitable for being used with sea water or water foam solution within industrial harsh environments & offshore applications.

Altre versioni disponibili

- Lancia schiuma Autoaspirante (vedi DS. B.30.30.20.20)

Other versions available

- Self-inducing foam branchpipe (see DS B.30.30.20.20)

Caratteristiche tecniche

Lancia

- Corpo in acciaio inox AISI 316
- Corpo ugello a scelta tra:
 - Bronzo EN 1982 – CC491K
 - Acciaio inox AISI 316
 - Lega di alluminio G-AISI9
- Attacco mediante Flangia ANSI 150
 - ASTM A 105
 - A182F316L
- Guarnizioni in EPDM
- Rapporto di espansione 1:6 (Varia con il tipo di schiumogeno)
- Esecuzione idonea ad installazione esterna in ambiente marino e funzionamento con acqua mare e soluzioni schiumogene
- Pressione di progetto 16 bar

Deflettore con attuatore manuale (LSM)

- Corpo in acciaio inox AISI 316
- Attuatore manuale e tirante in AISI 316

Deflettore con attuatore elettrico (LSE)

- Corpo in acciaio inox AISI 316
- Movimento getto pieno/nebulizzato realizzato mediante riduttore comandato da motore elettrico dotato di n° 2 limitatori di coppia di sicurezza (uno in apertura e uno in chiusura con contatti NA – NC) e n° 2 interruttori di fine corsa (uno in apertura e uno in chiusura con contatti NA –NC)
- Attuatore elettrico alimentazione 24 Vdc – IP 65 per il controllo del deflettore
- Resistenza anticondensa
- Comando manuale di emergenza per entrambi i movimenti a volantino di sicurezza disinseribile sempre inserito che non ruota durante la manovra elettrica
- Indicatore meccanico di posizione continuo a quadrante

Deflettore con attuatore oleodinamico (LSO)

- Corpo in acciaio inox AISI 316
- Attuatore oleodinamico in bronzo con leva per il comando di emergenza in AISI 316

Technical characteristics

Branchpipe

- Body in Stainless Steel AISI 316
- Nozzle body material to be selected among:
 - Bronze EN 1982 – CC491K
 - Stainless steel AISI 316
 - Aluminium alloy G-AISI9
- Flanged Connection ANSI 150
 - ASTM A 105
 - A182F316L
- EPDM Gasket
- Expansion ratio 1:6 (May vary depending on the foam concentrate)
- Suitable execution for external installation in marine environment and operation with sea water and foam solutions
- Design pressure: 16 bar

Manual actuator Spreaders (LSM)

- Stainless steel AISI 316 body
- Stainless steel AISI 316 manual actuator and lever

Electrically actuator Spreaders (LSE)

- Stainless steel AISI 316 body
- Full-flow/atomizing movement driven by geared electric motor with 2 safety torque limiters (one for opening and one for closing with NO - NC contacts) and 2 limit switches (one for opening and one for closing with NO -NC contacts)
- Electric actuator, supply voltage 24 Vdc – IP65 for spreaders control.
- Anti-condensation resistance
- Emergency manual control by hand wheel for both movements with disconnectable safety hand wheel always inserted that does not rotate during electric operation
- Mechanical position gauge

Hydraulic actuator Spreaders (LSO)

- Stainless steel AISI 316 body
- Bronze hydraulic actuator with AISI 316 emergency lever

Caratteristiche tecniche

Ciclo verniciatura standard SA:

Lancia

- Pulizia manuale con solvente
- Primer film secco 60 µm catalizzato al 30%
- Finitura poliuretano 60 µm catalizzato al 50%
- Spessore totale film secco 120 µm +/-10%
- Colore bianco RAL 9010

Attuatore manuale

- Finitura al naturale

Attuatore elettrico

- Colore rosso RAL 3000

Attuatore oleodinamico

- Colore rosso RAL 3000

Technical characteristics

Painting system standard SA:

Branchpipe

- Manual cleaning solvent
- Primer dry film 60 µm catalysed at 30%
- Polyurethane finish 60 µm catalysed at 50%
- Total thickness 120 µm dry film +/-10%
- Colour white RAL 9010

Manual actuator

- Natural finishing

Electrical actuator

- Colour red RAL 3000

Hydraulically actuator

- Colour red RAL 3000

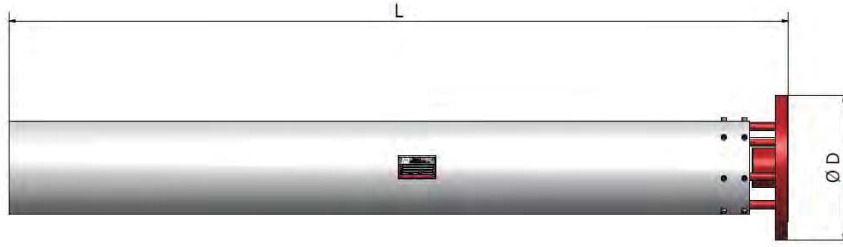

Ø D	L mm	Portata (l/min a 7 bar) Flow rate (lpm at 7 bar)							Peso Weight (kg)
		9000	10000	11000	12000	13000	14000	15000	
ANSI 150	1600	✓	✓	✓	✓	✓	✓	✓	24

Opzioni

- Ciclo di verniciatura diverso dallo Standard SA
- Per ulteriori opzioni o versioni speciali contattare SA Fire Protection

Optional

- Painting system different from Standard SA
- For additional options or special versions contact SA Fire Protection

Codice Identificativo
Identification Form

OPZIONI / OPTIONS

Mod. / / / /

1
2
3
4
5
6
7

Quantità / Quantity

LANCIA SCHIUMA LS / FOAM BRANCHPIPE LS					
CORPO BODY	1	Tipologia Type	Lancia schiuma Foam branchpipe	LS <input type="checkbox"/>	
			Lancia schiuma con deflettore manuale Foam branchpipe with manual spreader	LSM <input type="checkbox"/>	
			Lancia schiuma con deflettore elettrico Foam branchpipe with electric spreader	LSE <input type="checkbox"/>	
			Lancia schiuma con deflettore oleodinamico Foam branchpipe with hydraulic spreader	LSO <input type="checkbox"/>	
UGELLO NOZZLE	2	Materiale Material	Bronzo EN 1982 – CC491K Bronze EN 1982 – CC491K	CBG10 <input type="checkbox"/>	
			Acciaio inox AISI 316 Stainless steel AISI 316	CAI12 <input type="checkbox"/>	
			Lega di alluminio G-AISI9 Aluminium alloy G-AISI9	CAL10 <input type="checkbox"/>	Materiale standard Standard material
FLANGIA FLANGE	3	Materiale Material	Acciaio al carbonio Carbon steel	FAC20 <input type="checkbox"/>	Materiale standard Standard material
			Acciaio inox AISI 316L Stainless steel AISI 316L	FAI23 <input type="checkbox"/>	
	4	Tipologia Type	ANSI 150 lb RF	150RF <input type="checkbox"/>	
			ANSI 150 lb FF	150FF <input type="checkbox"/>	
	5	Dimensione Size	6"	6 <input type="checkbox"/>	
8"			8 <input type="checkbox"/>		
PORTATA FLOW RATE	6	Portata a 7 bar Flow rate at 7 bar	9000 l/min	90 <input type="checkbox"/>	
			10000 l/min	100 <input type="checkbox"/>	
			11000 l/min	110 <input type="checkbox"/>	
			12000 l/min	120 <input type="checkbox"/>	
			13000 l/min	130 <input type="checkbox"/>	
			14000 l/min	140 <input type="checkbox"/>	
			15000 l/min	150 <input type="checkbox"/>	
			Altro Other	F <input type="checkbox"/>	Specificare in Note la portata richiesta. Specify in Notes the flow rate required.
OPZIONI OPTIONS	7	Verniciatura Painting	Verniciatura diversa da ciclo SA standard Painting system different for SA standard	C <input type="checkbox"/>	Specificare in Note il ciclo di verniciatura richiesto. Specify in Notes the painting procedure required.

NOTE
NOTES

CLIENTE / CLIENT:	PROGETTO / PROJECT:	DOC. No.:	REV.:
EMESSO / ISSUED:	CONTROLLATO / CHECKED:	APPROVATO / APPROVED:	
DATA / DATE:	DATA / DATE:	DATA / DATE:	

LS-90	Diagrammi Prestazioni Performance Diagrams	LS-100
	<p>Pressione (bar) / Portata (l/min) Pressure (bar) / Flow Rate (lpm)</p>	
	<p>Pressione (bar) / Forza di Reazione (kg) Pressure (bar) / Reaction Force (kg)</p>	
	<p>Pressione (bar) / Gittata (m), angolo 30° Pressure (bar) / Throw (m), angle 30°</p>	
	<p>Traiettorie (m), angoli 30° e 75° @ 7 bar Trajectories (m), angles 30° and 75° @ 7 bar</p>	

LS-110	Diagrammi Prestazioni Performance Diagrams	LS-120
	<p>Pressione (bar) / Portata (l/min) Pressure (bar) / Flow Rate (lpm)</p>	
	<p>Pressione (bar) / Forza di Reazione (kg) Pressure (bar) / Reaction Force (kg)</p>	
	<p>Pressione (bar) / Gittata (m), angolo 30° Pressure (bar) / Throw (m), angle 30°</p>	
	<p>Traiettorie (m), angoli 30° e 75° @ 7 bar Trajectories (m), angles 30° and 75° @ 7 bar</p>	

LS-130	Diagrammi Prestazioni Performance Diagrams	LS-140
	<p>Pressione (bar) / Portata (l/min) Pressure (bar) / Flow Rate (lpm)</p>	
	<p>Pressione (bar) / Forza di Reazione (kg) Pressure (bar) / Reaction Force (kg)</p>	
	<p>Pressione (bar) / Gittata (m), angolo 30° Pressure (bar) / Throw (m), angle 30°</p>	
	<p>Traiettorie (m), angoli 30° e 75° @ 7 bar Trajectories (m), angles 30° and 75° @ 7 bar</p>	

LS-150	Diagrammi Prestazioni Performance Diagrams	-
	<p>Pressione (bar) / Portata (l/min) Pressure (bar) / Flow Rate (lpm)</p>	-
	<p>Pressione (bar) / Forza di Reazione (kg) Pressure (bar) / Reaction Force (kg)</p>	-
	<p>Pressione (bar) / Gittata (m), angolo 30° Pressure (bar) / Throw (m), angle 30°</p>	-
	<p>Traiettorie (m), angoli 30° e 75° @ 7 bar Trajectories (m), angles 30° and 75° @ 7 bar</p>	-

LANCIA AUTO-ASPIRANTE SCHIUMA – LSA 1000 – 8000 lpm SELF-INDUCING FOAM BRANCHPIPE – LSA



Mod. LSA



Mod. LSAM



Mod. LSAO

Descrizione



La lancia schiuma auto-aspirante LSA a bassa espansione è un dispositivo direzionale che viene montato sui monitori antincendio per proiettare getti di acqua/schiuma su lunghe distanze. La lancia è dotata di una gola Venturi capace di aspirare il liquido schiumogeno concentrato direttamente da fusti o serbatoi creando la miscela schiumogena direttamente nella camera di miscelazione della lancia. Un regolatore consente di variare la percentuale di miscelazione tra 0, il 3 ed il 6%. La lancia è costruita con un condotto di lancio dove è installato un ugello capace di generare una pressione negativa per aspirare aria all'interno del getto e favorire così il processo di emulsificazione della schiuma. La lancia LSA è disponibile con tre attacchi standard diversi: flangia quadra FQ 125, FQ 150 o F.BSP per il collegamento a monitori da 2 ½", 3" e 4". Su tutte le lance è possibile montare un deflettore che consente di governare il getto della lancia stessa ottenendo delle distribuzioni a getto aperto. I materiali di costruzione rendono la lancia versatile ed idonea per l'impiego con acqua di mare e soluzioni schiumogene all'interno di ambienti industriali ad alta aggressività o in applicazioni offshore.

Description



The self-inducing foam branchpipe LSA is a low expansion directional discharge device that is installed on firefighting monitors to project flows of foam in full jet condition. The branchpipe LSA is equipped with a built in Venturi nozzle which is capable to draw liquid concentrate for nearby bulks or tanks and mix it in the admix chamber. A regulating valve allow for the settings of mixing proportions between 0, 3 and 6%. The branchpipe is manufactured with a throw tube in which a nozzle is installed. The specific geometry allow for air entrainment into the jet that initiate the emulsification of foam moment before being projected in the air. The LSA Branchpipe is available with three different connections: square flanged SF125 and SF150 or F.BSP for connection with monitors of 2 ½", 3" and 4". All branchpipes can be equipped with a spreader which allow to control the discharge from full jet to wide open stream. The material of construction available varies making the nozzle suitable for being used with sea water or water foam solution within industrial harsh environments & offshore applications.

Altre versioni disponibili

- Lancia schiuma standard (vedi DS. B.30.30.10.10)

Other versions available

- Standard Foam branchpipe (see DS B.30.30.10.10)

Caratteristiche tecniche

Lancia

- Corpo in acciaio inox AISI 316
- Blocco di aspirazione a scelta tra:
 - Bronzo EN 1982 – CC491K
 - Lega di alluminio G-AISI9
- Corpo ugello a scelta tra:
 - Bronzo EN 1982 – CC491K
 - Acciaio inox AISI 316
 - Lega di alluminio G-AISI9
- Tubo pescante in PVC con spirale interna d'acciaio, attacco F.G. UNI 25, terminale tubo in PVC
- Valvola d'aspirazione schiumogeno con dispositivo di regolazione percentuale di miscelazione : 0 – 3% - 6%
- Attacco mediante:
 - FQ 125
 - FQ 150
 - F.BSP
- Rapporto di espansione 1:4 (Varia con il tipo di schiumogeno)
- Esecuzione idonea ad installazione esterna in ambiente marino e funzionamento con acqua mare e soluzioni schiumogene
- Pressione di progetto: 16 bar

Deflettore con attuatore manuale (LSAM)

- Corpo in acciaio inox AISI 316
- Attuatore manuale e tirante in AISI 316

Deflettore con attuatore elettrico (LSAE)

- Corpo in acciaio inox AISI 316
- Movimento getto pieno/nebulizzato realizzato mediante riduttore comandato da motore elettrico dotato di n° 2 limitatori di coppia di sicurezza (uno in apertura e uno in chiusura con contatti NA – NC) e n° 2 interruttori di fine corsa (uno in apertura e uno in chiusura con contatti NA –NC)
- Attuatore elettrico alimentazione 24 Vdc – IP 65 per il controllo del deflettore
- Resistenza anticondensa
- Comando manuale di emergenza per entrambi i movimenti a volantino di sicurezza disinseribile sempre inserito che non ruota durante la manovra elettrica
- Indicatore meccanico di posizione continuo a quadrante

Deflettore con attuatore oleodinamico (LSAO)

- Corpo in acciaio inox AISI 316
- Attuatore oleodinamico in bronzo con leva per il comando di emergenza in AISI 316

Technical characteristics

Branchpipe

- Body in Stainless Steel AISI 316
- Inducing device body material to be selected among:
 - Bronze EN 1982 – CC491K
 - Aluminium alloy G-AISI9
- Nozzle body material to be selected among:
 - Bronze EN 1982 – CC491K
 - Stainless steel AISI 316
 - Aluminium alloy G-AISI9
- Dip tube in PVC with internal steel spiral reinforcement, connection UNI 25, rigid terminal tube in PVC
- Foam suction valve with mixing ratio selector : 0 - 3% - 6%
- Connection:
 - SF 125
 - SF 150
 - F.BSP
- Expansion ratio 1:4 (May vary depending on the foam concentrate)
- Suitable execution for external installation in marine environment and operation with sea water and foam solutions
- Design pressure: 16 bar

Manual actuator Spreaders (LSAM)

- Stainless steel AISI 316 body
- Stainless steel AISI 316 manual actuator and lever

Electrically actuator Spreaders (LSAE)

- Stainless steel AISI 316 body
- Full-flow/atomizing movement driven by geared electric motor with 2 safety torque limiters (one for opening and one for closing with NO - NC contacts) and 2 limit switches (one for opening and one for closing with NO -NC contacts)
- Electric actuator, supply voltage 24 Vdc – IP65 for spreaders control.
- Anti-condensation resistance
- Emergency manual control by hand wheel for both movements with disconnectable safety hand wheel always inserted that does not rotate during electric operation
- Mechanical position gauge

Hydraulic actuator Spreaders (LSAO)

- Stainless steel AISI 316 body
- Bronze hydraulic actuator with AISI 316 emergency lever

Caratteristiche tecniche

Ciclo verniciatura standard SA:

Lancia

- Pulizia manuale con solvente
- Primer film secco 60 µm catalizzato al 30%
- Finitura poliuretano 60 µm catalizzato al 50%
- Spessore totale film secco 120 µm +/-10%
- Colore bianco RAL 9010

Attuatore manuale

- Finitura al naturale

Attuatore elettrico

- Colore rosso RAL 3000

Attuatore oleodinamico

- Colore rosso RAL 3000

Technical characteristics

Painting system standard SA:

Branchpipe

- Manual cleaning solvent
- Primer dry film 60 µm catalysed at 30%
- Polyurethane finish 60 µm catalysed at 50%
- Total thickness 120 µm dry film +/-10%
- Colour white RAL 9010

Manual actuator

- Natural finishing

Electrical actuator

- Colour red RAL 3000

Hydraulically actuator

- Colour red RAL 3000

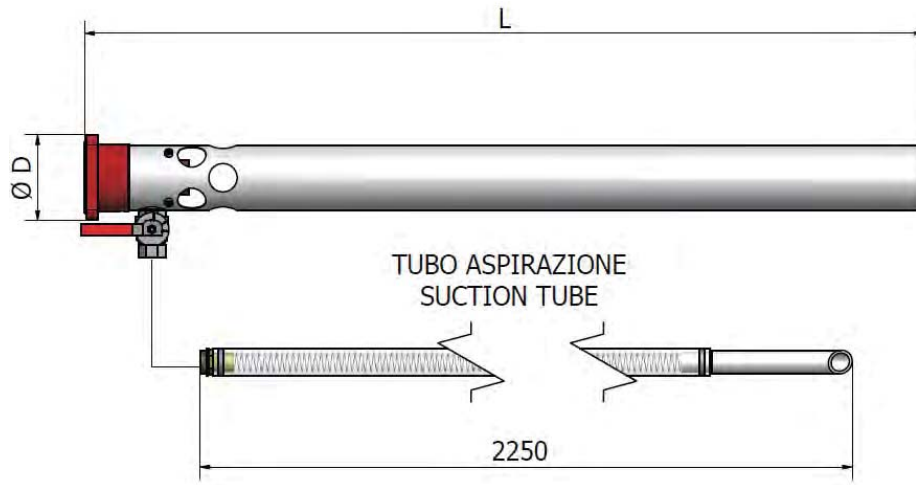

Ø D	L mm	Portata (l/min a 7 bar) Flow rate (lpm at 7 bar)											Peso Weight (kg)	
		1000	1500	2000	2500	3000	3500	4000	5000	6000	7000	8000		
FQ125 SF125	1200	✓	✓	✓	✓	✗	✗	✗	✗	✗	✗	✗	✗	11
	1500	✗	✗	✗	✗	✓	✓	✗	✗	✗	✗	✗	✗	14
	1600	✗	✗	✗	✗	✗	✗	✓	✗	✗	✗	✗	✗	15
FQ150 SF150	1200	✓	✓	✓	✓	✗	✗	✗	✗	✗	✗	✗	✗	12
	1500	✗	✗	✗	✗	✓	✓	✗	✗	✗	✗	✗	✗	16
	1600	✗	✗	✗	✗	✗	✗	✓	✓	✓	✓	✓	✓	17
F.BSP 2 1/2"	1200	✓	✓	✓	✗	✗	✗	✗	✗	✗	✗	✗	✗	11
F.BSP 3"	1200	✓	✓	✓	✓	✗	✗	✗	✗	✗	✗	✗	✗	12
	1500	✗	✗	✗	✗	✓	✓	✗	✗	✗	✗	✗	✗	15
	1600	✗	✗	✗	✗	✗	✗	✓	✗	✗	✗	✗	✗	16
F.BSP 4"	1200	✓	✓	✓	✓	✗	✗	✗	✗	✗	✗	✗	✗	13
	1500	✗	✗	✗	✗	✓	✓	✗	✗	✗	✗	✗	✗	16
	1600	✗	✗	✗	✗	✗	✗	✓	✓	✓	✓	✓	✓	17

Opzioni

- Ciclo di verniciatura diverso dallo Standard SA
- Tubo di aspirazione lunghezza diversa
- Per ulteriori opzioni o versioni speciali contattare SA Fire Protection

Optional

- Painting system different from Standard SA
- Different length dip tube
- For additional options or special versions contact SA Fire Protection

Codice Identificativo
Identification Form

OPZIONI / OPTIONS

Mod. / / / / /

Quantità / Quantity

LANCIA SCHIUMA AUTO-ASPIRANTE LSA / SELF-INDUCING FOAM BRANCHPIPE LSA

CORPO BODY	1	Tipologia Type	Lancia schiuma auto-aspirante Self-inducing foam branchpipe	LSA <input type="checkbox"/>	
			Lancia schiuma auto-aspirante con deflettore manuale Self-inducing foam branchpipe with manual spreader	LSAM <input type="checkbox"/>	
			Lancia schiuma auto-aspirante con deflettore elettrico Self-inducing foam branchpipe with electric spreader	LSAE <input type="checkbox"/>	
			Lancia schiuma auto-aspirante con deflettore oleodinamico Self-inducing foam branchpipe with hydraulic spreader	LSAO <input type="checkbox"/>	
ASPIRAZIONE INDUCTOR	2	Materiale Material	Bronzo EN 1982 – CC491K Bronze EN 1982 – CC491K	CBG10 <input type="checkbox"/>	
			Lega di alluminio G-AISI9 Aluminium alloy G-AISI9	CAL10 <input type="checkbox"/>	
UGELLO NOZZLE	3	Materiale Material	Bronzo EN 1982 – CC491K Bronze EN 1982 – CC491K	CBG10 <input type="checkbox"/>	
			Acciaio inox AISI 316 Stainless steel AISI 316	CAI12 <input type="checkbox"/>	
			Lega di alluminio G-AISI9 Aluminium alloy G-AISI9	CAL10 <input type="checkbox"/>	Materiale standard Standard material
FLANGIA FLANGE	4	Dimensione Size	FQ 125 SF 125	125 <input type="checkbox"/>	
			FQ 150 SF 150	150 <input type="checkbox"/>	
			F. BSP 2 1/2"	2M <input type="checkbox"/>	
			F. BSP 3"	3 <input type="checkbox"/>	
			F. BSP 4"	4 <input type="checkbox"/>	
PORTATA FLOW RATE	5	Portata a 7 bar Flow rate at 7 bar	1000 l/min	10 <input type="checkbox"/>	
			1500 l/min	15 <input type="checkbox"/>	
			2000 l/min	20 <input type="checkbox"/>	
			2500 l/min	25 <input type="checkbox"/>	
			3000 l/min	30 <input type="checkbox"/>	
			3500 l/min	35 <input type="checkbox"/>	
			4000 l/min	40 <input type="checkbox"/>	
			5000 l/min	50 <input type="checkbox"/>	
			6000 l/min	60 <input type="checkbox"/>	
			7000 l/min	70 <input type="checkbox"/>	
			8000 l/min	80 <input type="checkbox"/>	
Altro Other	F <input type="checkbox"/>	Specificare in Note la portata richiesta. Specify in Notes the flow rate required.			

OPZIONI OPTIONS	6 Verniciatura Painting	Verniciatura diversa da ciclo SA standard Painting system different for SA standard	<input type="checkbox"/> C	Specificare in Note il ciclo di verniciatura richiesto. Specify in Notes the painting procedure required.
	7 Tubo aspirazione Dip tube	Inserire la lunghezza desiderata in mm Insert the required length in mm	<input type="checkbox"/> ()	Compilare solo se diverso da standard. Lunghezza max. 3 m. To be filled only if different from standard. Max. length 3 m.
NOTE NOTES				
	CLIENTE / CLIENT:		PROGETTO / PROJECT:	DOC. No.:
EMESSO / ISSUED:		CONTROLLATO / CHECKED:	APPROVATO / APPROVED:	
DATA / DATE:		DATA / DATE:	DATA / DATE:	

LSA-10	Diagrammi Prestazioni Performance Diagrams	LSA-15
	<p>Pressione (bar) / Portata (l/min) Pressure (bar) / Flow Rate (lpm)</p>	
	<p>Pressione (bar) / Forza di Reazione (kg) Pressure (bar) / Reaction Force (kg)</p>	
	<p>Pressione (bar) / Gittata (m), angolo 30° Pressure (bar) / Throw (m), angle 30°</p>	
	<p>Traiettorie (m), angoli 30° e 75° @ 7 bar Trajectories (m), angles 30° and 75° @ 7 bar</p>	

LSA-20	Diagrammi Prestazioni Performance Diagrams	LSA-25
	<p>Pressione (bar) / Portata (l/min) Pressure (bar) / Flow Rate (lpm)</p>	
	<p>Pressione (bar) / Forza di Reazione (kg) Pressure (bar) / Reaction Force (kg)</p>	
	<p>Pressione (bar) / Gittata (m), angolo 30° Pressure (bar) / Throw (m), angle 30°</p>	
	<p>Traiettorie (m), angoli 30° e 75° @ 7 bar Trajectories (m), angles 30° and 75° @ 7 bar</p>	

LSA-30	Diagrammi Prestazioni Performance Diagrams	LSA-35
	<p>Pressione (bar) / Portata (l/min) Pressure (bar) / Flow Rate (lpm)</p>	
	<p>Pressione (bar) / Forza di Reazione (kg) Pressure (bar) / Reaction Force (kg)</p>	
	<p>Pressione (bar) / Gittata (m), angolo 30° Pressure (bar) / Throw (m), angle 30°</p>	
	<p>Traiettorie (m), angoli 30° e 75° @ 7 bar Trajectories (m), angles 30° and 75° @ 7 bar</p>	

LSA-40	Diagrammi Prestazioni Performance Diagrams	LSA-50
	<p>Pressione (bar) / Portata (l/min) Pressure (bar) / Flow Rate (lpm)</p>	
	<p>Pressione (bar) / Forza di Reazione (kg) Pressure (bar) / Reaction Force (kg)</p>	
	<p>Pressione (bar) / Gittata (m), angolo 30° Pressure (bar) / Throw (m), angle 30°</p>	
	<p>Traiettorie (m), angoli 30° e 75° @ 7 bar Trajectories (m), angles 30° and 75° @ 7 bar</p>	

LSA-60	Diagrammi Prestazioni Performance Diagrams	LSA-70
	<p>Pressione (bar) / Portata (l/min) Pressure (bar) / Flow Rate (lpm)</p>	
	<p>Pressione (bar) / Forza di Reazione (kg) Pressure (bar) / Reaction Force (kg)</p>	
	<p>Pressione (bar) / Gittata (m), angolo 30° Pressure (bar) / Throw (m), angle 30°</p>	
	<p>Traiettorie (m), angoli 30° e 75° @ 7 bar Trajectories (m), angles 30° and 75° @ 7 bar</p>	

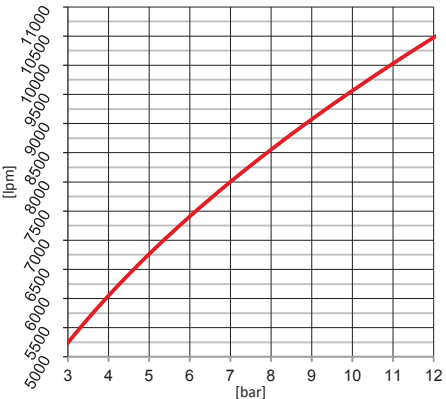
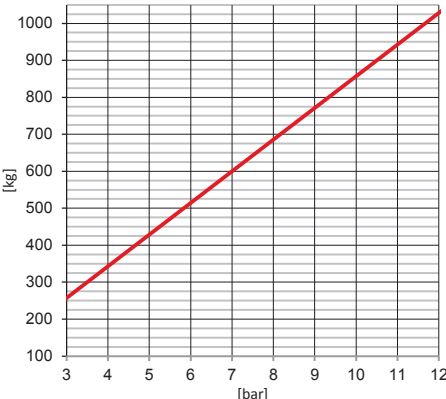
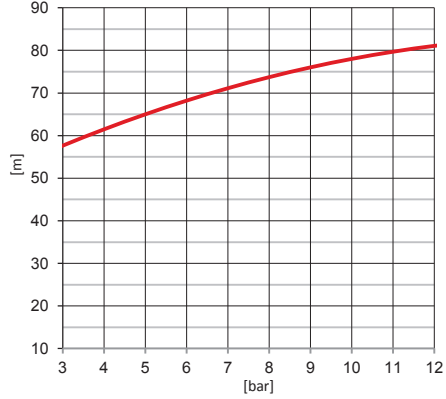
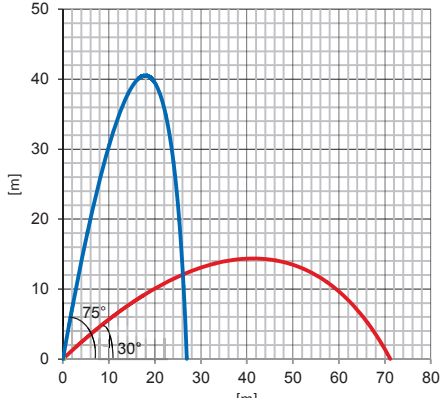
LSA-80	Diagrammi Prestazioni Performance Diagrams	-
	<p>Pressione (bar) / Portata (l/min) Pressure (bar) / Flow Rate (lpm)</p>	-
	<p>Pressione (bar) / Forza di Reazione (kg) Pressure (bar) / Reaction Force (kg)</p>	-
	<p>Pressione (bar) / Gittata (m), angolo 30° Pressure (bar) / Throw (m), angle 30°</p>	-
	<p>Traiettorie (m), angoli 30° e 75° @ 7 bar Trajectories (m), angles 30° and 75° @ 7 bar</p>	-

LANCIA AUTO-ASPIRANTE SCHIUMA – LSA
SELF-INDUCING FOAM BRANCHPIPE – LSA 9000 – 15000 lpm

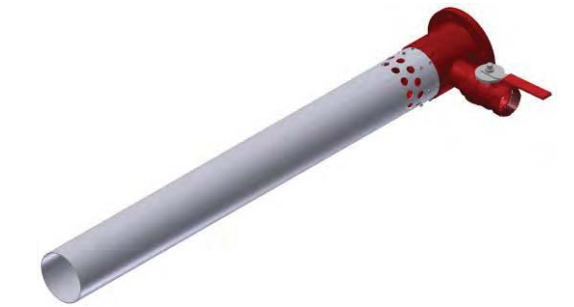

Mod. LSA



Mod. LSAM



Mod. LSAO

Descrizione



La lancia schiuma auto-aspirante LSA è un dispositivo direzionale che viene montato sui monitori antincendio per proiettare getti di acqua/schiuma su lunghe distanze. La lancia è dotata di una gola Venturi capace di aspirare il liquido schiumogeno concentrato direttamente da fusti o serbatoi creando la miscela schiumogena direttamente nella camera di miscelazione della lancia. Un regolatore consente di variare la percentuale di miscelazione tra 0, il 3 ed il 6%. La lancia è costruita con un condotto di lancio dove è installato un ugello capace di generare una pressione negativa per aspirare aria all'interno del getto e favorire così il processo di emulsificazione della schiuma. La lancia LSA è disponibile con attacco flangiato ANSI 150 in acciaio al carbonio o inox per il collegamento a monitori da 6" ed 8". Su tutte le lance è possibile montare un deflettore che consente di governare il getto della lancia stessa ottenendo delle distribuzioni a getto aperto. I materiali di costruzione rendono la lancia versatile ed idonea per l'impiego con acqua di mare e soluzioni schiumogene all'interno di ambienti industriali ad alta aggressività o in applicazioni offshore.

Description



The self-inducing foam branchpipe LSA is a directional discharge device that is installed on firefighting monitors to project flows of foam in full jet condition. The branchpipe LSA is equipped with a built in Venturi nozzle which is capable to draw liquid concentrate for nearby bulks or tanks and mix it in the admix chamber. A regulating valve allow for the settings of mixing proportions between 0, 3 and 6%. The branchpipe is manufactured with a throw tube in which a nozzle is installed. The specific geometry allow for air entrainment into the jet that initiate the emulsification of foam moment before being projected in the air. The LSA branchpipe is available with a flanged connection ANSI 150 in carbon steel or stainless steel for connection with monitors of 6" and 8". All branchpipes can be equipped with a spreader which allow to control the discharge from full jet to wide open stream. The material of construction available varies making the nozzle suitable for being used with sea water or water foam solution within industrial harsh environments & offshore applications.

Altre versioni disponibili

- Lancia schiuma standard (vedi DS. B.30.30.10.20)

Other versions available

- Standard foam branchpipe (see DS B.30.30.10.20)

Caratteristiche tecniche

- Corpo in acciaio inox AISI 316
- Blocco di aspirazione a scelta tra:
 - Bronzo EN 1982 – CC491K
 - Lega di alluminio G-AISI9
- Corpo ugello a scelta tra:
 - Bronzo EN 1982 – CC491K
 - Acciaio inox AISI 316
 - Lega di alluminio G-AISI9
- Tubo pescante in PVC con spirale interna d'acciaio, attacco UNI ISO 228/1 – G3", terminale tubo in PVC
- Valvola d'aspirazione schiumogeno con dispositivo di regolazione percentuale di miscelazione : 0 – 1% - 3% - 6%
- Attacco mediante Flangia ANSI 150
 - ASTM A 105
 - A182F316L
- Rapporto di espansione 1:6 (Varia con il tipo di schiumogeno)
- Esecuzione idonea ad installazione esterna in ambiente marino e funzionamento con acqua mare e soluzioni schiumogene
- Pressione di progetto 16 bar

Deflettore con attuatore manuale (LSAM)

- Corpo in acciaio inox AISI 316
- Attuatore manuale e tirante in AISI 316

Deflettore con attuatore elettrico (LSAE)

- Corpo in acciaio inox AISI 316
- Movimento getto pieno/nebulizzato realizzato mediante riduttore comandato da motore elettrico dotato di n° 2 limitatori di coppia di sicurezza (uno in apertura e uno in chiusura con contatti NA – NC) e n° 2 interruttori di fine corsa (uno in apertura e uno in chiusura con contatti NA –NC)
- Attuatore elettrico alimentazione 24 Vdc – IP 65 per il controllo del deflettore
- Resistenza anticondensa
- Comando manuale di emergenza per entrambi i movimenti a volantino di sicurezza disinseribile sempre inserito che non ruota durante la manovra elettrica
- Indicatore meccanico di posizione continuo a quadrante

Deflettore con attuatore oleodinamico (LSAO)

- Corpo in acciaio inox AISI 316
- Attuatore oleodinamico in bronzo con leva per il comando di emergenza in AISI 316

Technical characteristics

- Body in Stainless Steel AISI 316
- Inducing device body material to be selected among:
 - Bronze EN 1982 – CC491K
 - Aluminium alloy G-AISI9
- Nozzle body material to be selected among:
 - Bronze EN 1982 – CC491K
 - Stainless steel AISI 316
 - Aluminium alloy G-AISI9
- Dip tube in PVC with internal steel spiral reinforcement, connection UNI ISO 228/1 – G3", rigid terminal tube in PVC
- Foam suction valve with mixing ratio selector : 0 - 1% - 3% - 6%
- Flanged Connection ANSI 150
 - ASTM A 105
 - A182F316L
- Expansion ratio 1:6 (May vary depending on the foam concentrate)
- Suitable execution for external installation in marine environment and operation with sea water and foam solutions
- Design pressure: 16 bar

Manual actuator Spreaders (LSAM)

- Stainless steel AISI 316 body
- Stainless steel AISI 316 manual actuator and lever

Electrically actuator Spreaders (LSAE)

- Stainless steel AISI 316 body
- Full-flow/atomizing movement driven by geared electric motor with 2 safety torque limiters (one for opening and one for closing with NO - NC contacts) and 2 limit switches (one for opening and one for closing with NO -NC contacts)
- Electric actuator, supply voltage 24 Vdc – IP65 for spreaders control.
- Anti-condensation resistance
- Emergency manual control by hand wheel for both movements with disconnectable safety hand wheel always inserted that does not rotate during electric operation
- Mechanical position gauge

Hydraulic actuator Spreaders (LSAO)

- Stainless steel AISI 316 body
- Bronze hydraulic actuator with AISI 316 emergency lever

Caratteristiche tecniche

Ciclo verniciatura standard SA:

Lancia

- Pulizia manuale con solvente
- Primer film secco 60 µm catalizzato al 30%
- Finitura poliuretano 60 µm catalizzato al 50%
- Spessore totale film secco 120 µm +/-10%
- Colore bianco RAL 9010

Attuatore manuale

- Finitura al naturale

Attuatore elettrico

- Colore rosso RAL 3000

Attuatore oleodinamico

- Colore rosso RAL 3000

Technical characteristics

Painting system standard SA:

Branchpipe

- Manual cleaning solvent
- Primer dry film 60 µm catalysed at 30%
- Polyurethane finish 60 µm catalysed at 50%
- Total thickness 120 µm dry film +/-10%
- Colour white RAL 9010

Manual actuator

- Natural finishing

Electrical actuator

- Colour red RAL 3000

Hydraulically actuator

- Colour red RAL 3000

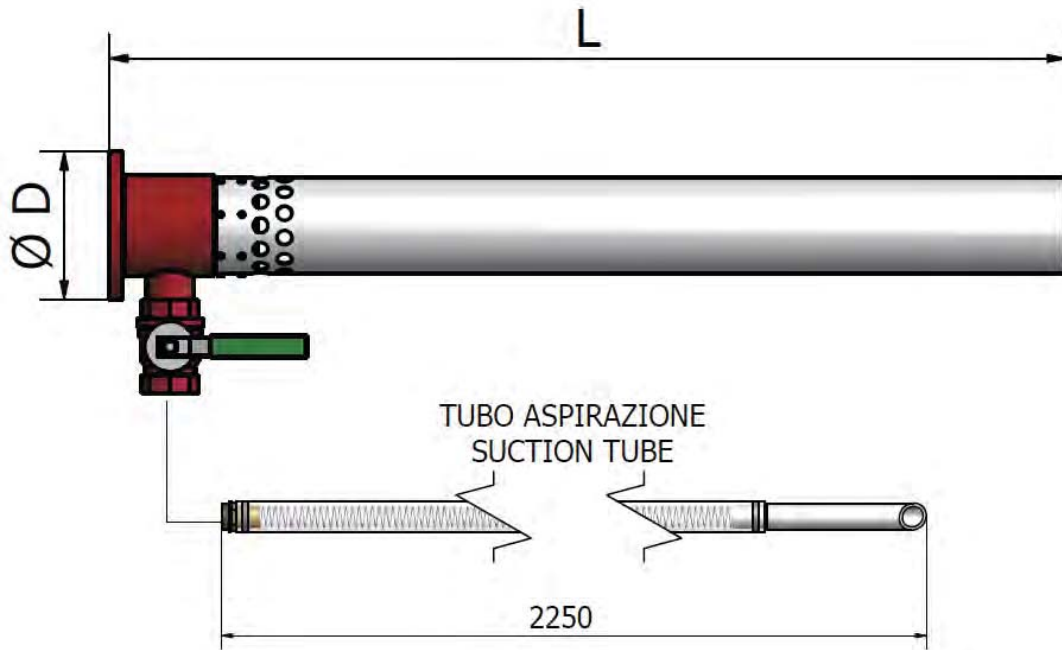

Ø D	L mm	Portata (l/min a 7 bar) Flow rate (lpm at 7 bar)							Peso Weight (kg)
		9000	10000	11000	12000	13000	14000	15000	
ANSI 150	1800	✓	✓	✓	✓	✓	✓	✓	42

Opzioni

- Ciclo di verniciatura diverso dallo Standard SA
- Tubo di aspirazione lunghezza diversa
- Per ulteriori opzioni o versioni speciali contattare SA Fire Protection

Optional

- Painting system different from Standard SA
- Different length dip tube
- For additional options or special versions contact SA Fire Protection

Codice Identificativo
Identification Form

OPZIONI / OPTIONS

Mod. / / / / /

1
 2
 3
 4
 5
 6
 7
 8
 9

Quantità / Quantity

LANCIA SCHIUMA AUTO – ASPIRANTE / SELF – INDUCING FOAM BRANCHPIPE					
CORPO BODY	1	Tipologia Type	Lancia schiuma auto-aspirante Self-inducing foam branchpipe	LSA <input type="checkbox"/>	
			Lancia schiuma auto-aspirante con deflettore manuale Self-inducing foam branchpipe with manual spreader	LSAM <input type="checkbox"/>	
			Lancia schiuma auto-aspirante con deflettore elettrico Self-inducing foam branchpipe with electric spreader	LSAE <input type="checkbox"/>	
			Lancia schiuma auto-aspirante con deflettore oleodinamico Self-inducing foam branchpipe with hydraulic spreader	LSAO <input type="checkbox"/>	
ASPIRAZIONE INDUCTOR	2	Materiale Material	Bronzo EN 1982 – CC491K Bronze EN 1982 – CC491K	CBG10 <input type="checkbox"/>	
			Lega di alluminio G-AISI9 Aluminium alloy G-AISI9	CAL10 <input type="checkbox"/>	
UGELLO NOZZLE	3	Materiale Material	Bronzo EN 1982 – CC491K Bronze EN 1982 – CC491K	CBG10 <input type="checkbox"/>	
			Acciaio inox AISI 316 Stainless steel AISI 316	CAI12 <input type="checkbox"/>	
			Lega di alluminio G-AISI9 Aluminium alloy G-AISI9	CAL10 <input type="checkbox"/>	Materiale standard Standard material
FLANGIA FLANGE	4	Materiale Material	Acciaio al carbonio Carbon steel	FAC20 <input type="checkbox"/>	
			Acciaio inox AISI 316L Stainless steel AISI 316L	FAI23 <input type="checkbox"/>	
	5	Tipologia Type	ANSI 150 lb RF	150RF <input type="checkbox"/>	
			ANSI 150 lb FF	150FF <input type="checkbox"/>	
	6	Dimensione Size	6"	6 <input type="checkbox"/>	
			8"	8 <input type="checkbox"/>	
PORTATA FLOW RATE	7	Portata a 7 bar Flow rate at 7 bar	9000 l/min	90 <input type="checkbox"/>	
			10000 l/min	100 <input type="checkbox"/>	
			11000 l/min	110 <input type="checkbox"/>	
			12000 l/min	120 <input type="checkbox"/>	
			13000 l/min	130 <input type="checkbox"/>	
			14000 l/min	140 <input type="checkbox"/>	
			15000 l/min	150 <input type="checkbox"/>	
			Altro Other	F <input type="checkbox"/>	Specificare in Note la portata richiesta. Specify in Notes the flow rate required.
OPZIONI OPTIONS	8	Verniciatura Painting	Verniciatura diversa da ciclo SA standard Painting system different for SA standard	C <input type="checkbox"/>	Specificare in Note il ciclo di verniciatura richiesto. Specify in Notes the painting procedure required.
			Tubo aspirazione Dip tube	Inserire la lunghezza desiderata in mm Insert the required length in mm	(___) <input type="checkbox"/>

NOTE
NOTES

CLIENTE / CLIENT:	PROGETTO / PROJECT:	DOC. No.:	REV.:
EMESSO / ISSUED:	CONTROLLATO / CHECKED:	APPROVATO / APPROVED:	
DATA / DATE:	DATA / DATE:	DATA / DATE:	

LSA-90	Diagrammi Prestazioni Performance Diagrams	LSA-100
	<p>Pressione (bar) / Portata (l/min) Pressure (bar) / Flow Rate (lpm)</p>	
	<p>Pressione (bar) / Forza di Reazione (kg) Pressure (bar) / Reaction Force (kg)</p>	
	<p>Pressione (bar) / Gittata (m), angolo 30° Pressure (bar) / Throw (m), angle 30°</p>	
	<p>Traiettorie (m), angoli 30° e 75° @ 7 bar Trajectories (m), angles 30° and 75° @ 7 bar</p>	

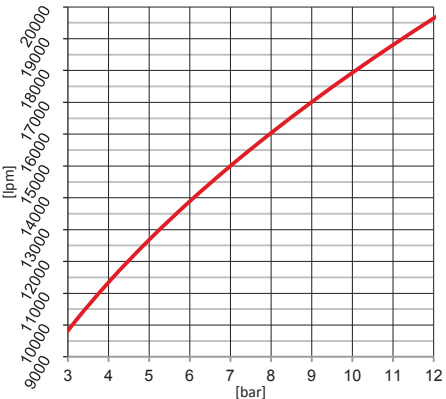
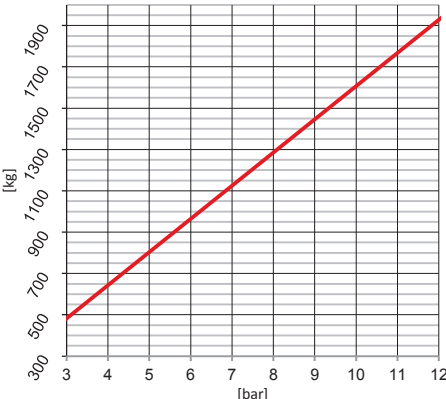
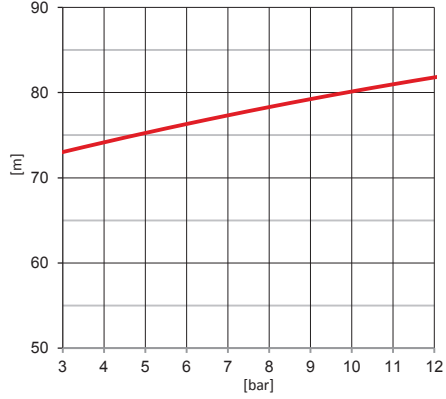
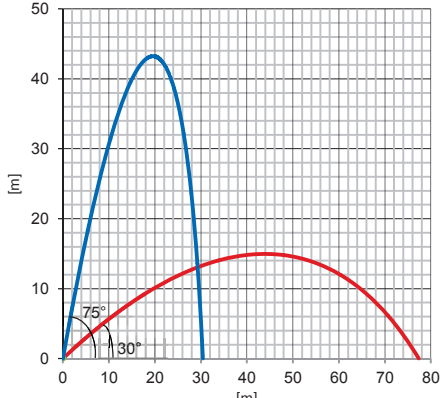

LSA-110	Diagrammi Prestazioni Performance Diagrams	LSA-120
	<p>Pressione (bar) / Portata (l/min) Pressure (bar) / Flow Rate (lpm)</p>	
	<p>Pressione (bar) / Forza di Reazione (kg) Pressure (bar) / Reaction Force (kg)</p>	
	<p>Pressione (bar) / Gittata (m), angolo 30° Pressure (bar) / Throw (m), angle 30°</p>	
	<p>Traiettorie (m), angoli 30° e 75° @ 7 bar Trajectories (m), angles 30° and 75° @ 7 bar</p>	

LSA-130	Diagrammi Prestazioni Performance Diagrams	LSA-140
	<p>Pressione (bar) / Portata (l/min) Pressure (bar) / Flow Rate (lpm)</p>	
	<p>Pressione (bar) / Forza di Reazione (kg) Pressure (bar) / Reaction Force (kg)</p>	
	<p>Pressione (bar) / Gittata (m), angolo 30° Pressure (bar) / Throw (m), angle 30°</p>	
	<p>Traiettorie (m), angoli 30° e 75° @ 7 bar Trajectories (m), angles 30° and 75° @ 7 bar</p>	

LSA-150	Diagrammi Prestazioni Performance Diagrams	-
	<p>Pressione (bar) / Portata (l/min) Pressure (bar) / Flow Rate (lpm)</p>	-
	<p>Pressione (bar) / Forza di Reazione (kg) Pressure (bar) / Reaction Force (kg)</p>	-
	<p>Pressione (bar) / Gittata (m), angolo 30° Pressure (bar) / Throw (m), angle 30°</p>	-
	<p>Traiettorie (m), angoli 30° e 75° @ 7 bar Trajectories (m), angles 30° and 75° @ 7 bar</p>	-

LANCIA IDRICA – LI
WATER BRANCHPIPE – LI 1000 – 8000 lpm



Descrizione		Description	
<p>La lancia idrica LI è un dispositivo direzionale che viene montato sui monitori antincendio per proiettare getti di acqua su lunghe distanze. La lancia è costruita con un condotto di lancio dove è installato un ugello terminale che accelera la velocità del flusso per proiettarlo in aria e raggiungere la massima distanza. La lancia LI è disponibile con tre attacchi standard diversi: flangia quadra FQ 125, FQ 150, ANSI 150 o F.BSP per il collegamento a monitori da 2 ½”, 3”, 4” e 6”. I materiali di costruzione rendono la lancia versatile ed idonea per l’impiego con acqua di mare all’interno di ambienti industriali ad alta aggressività o in applicazioni offshore.</p>		<p>The water branchpipe LI is a directional discharge device that is installed on firefighting monitors to project flows of water in full jet condition. The branchpipe is manufactured with a throw tube in which a nozzle is installed. The specific geometry allow for the stream to be accelerated in order to be projected in air and achieve the maximum throw. The LI Branchpipe is available with three different connections: square flanged SF125, SF150, ANSI 150 or F.BSP for connection with monitors of 2 ½”, 3”, 4” and 6”. The material of construction available varies making the nozzle suitable for being used with sea water within industrial harsh environments & offshore applications.</p>	

Caratteristiche tecniche

- Corpo in acciaio inox AISI 316
- Corpo ugello a scelta tra:
 - Bronzo EN 1982 – CC491K
 - Lega di alluminio G-AISI9
- Attacco mediante:
 - FQ 125
 - FQ 150
 - 6" ANSI 150
 - F.BSP
- Esecuzione idonea ad installazione esterna in ambiente marino e funzionamento con acqua mare
- Pressione di progetto 16 bar

Ciclo verniciatura standard SA:

- Pulizia manuale con solvente
- Primer epossidico 60 µm
- Finitura poliuretano 60 µm
- Spessore totale film secco 120 µm +/-10%
- Colore rosso RAL 3000

Technical characteristics

- Body in Stainless Steel AISI 316
- Nozzle body material to be selected among:
 - Bronze EN 1982 – CC491K
 - Aluminium alloy G-AISI9
- Connection:
 - SF 125
 - SF 150
 - 6" ANSI 150
 - F.BSP
- Suitable execution for external installation in marine environment and operation with sea water
- Design pressure: 16 bar

Painting system standard SA:

- Manual cleaning solvent
- Epoxy primer 60 µm
- Polyurethane finish 60 µm
- Total thickness 120 µm dry film +/-10%
- Colour red RAL 3000

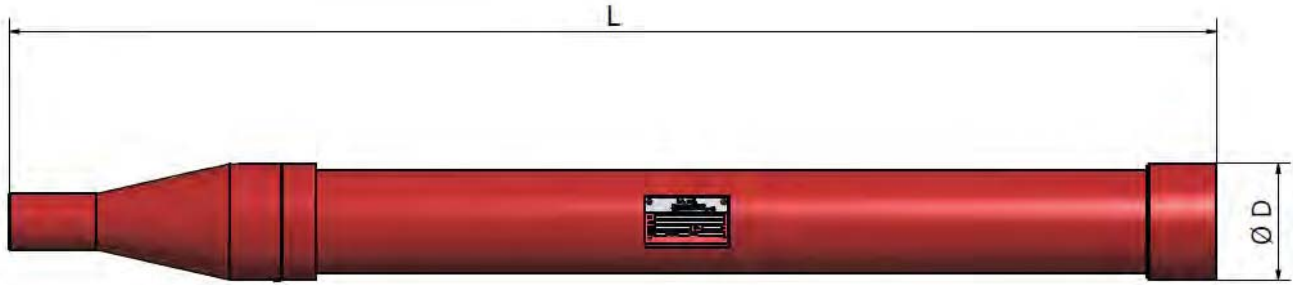

Ø D	L mm	Portata (l/min a 7 bar) Flow rate (lpm at 7 bar)											Peso Weight (kg)	
		1000	1500	2000	2500	3000	3500	4000	5000	6000	7000	8000		
FQ125 SF125	1000	✓	✓	✓	✓	✓	✓	✓	✓	✗	✗	✗	✗	7
FQ150 SF150	1000	✓	✓	✓	✓	✓	✓	✓	✓	✓	✓	✓	✓	11
6" ANSI 150	1000	✗	✗	✗	✗	✗	✗	✓	✓	✓	✓	✓	12	
F.BSP 2 1/2"	1000	✓	✓	✓	✗	✗	✗	✗	✗	✗	✗	✗	7	
F.BSP 3"	1000	✓	✓	✓	✓	✓	✓	✓	✗	✗	✗	✗	7	
F.BSP 4"	1000	✓	✓	✓	✓	✓	✓	✓	✓	✓	✓	✓	11	

Opzioni

- Ciclo di verniciatura diverso dallo Standard SA
- Per ulteriori opzioni o versioni speciali contattare SA Fire Protection

Optional

- Painting system different from Standard SA
- For additional options or special versions contact SA Fire Protection

Codice Identificativo
Identification Form

OPZIONI / OPTIONS

Mod. / / / /

1
2
3
4
5

Quantità / Quantity

LANCIA IDRICA / WATER BRANCHPIPE

LANCIA IDRICA / WATER BRANCHPIPE					
CORPO BODY	1	Tipologia Type	Lancia idrica Foam branchpipe	LI <input checked="" type="checkbox"/>	
		UGELLO NOZZLE	Materiale Material	Bronzo EN 1982 – CC491K Bronze EN 1982 – CC491K	CBG10 <input type="checkbox"/>
				Lega di alluminio G-AISI9 Aluminium alloy G-AISI9	CAL10 <input type="checkbox"/>
FLANGIA FLANGE	3	Dimensione Size	FQ 125 SF 125	125 <input type="checkbox"/>	
			FQ 150 SF 150	150 <input type="checkbox"/>	
			ANSI 6"	6 <input type="checkbox"/>	
			F. BSP 2 1/2"	2M <input type="checkbox"/>	
			F. BSP 3"	3 <input type="checkbox"/>	
			F. BSP 4"	4 <input type="checkbox"/>	
PORTATA FLOW RATE	4	Portata a 7 bar Flow rate at 7 bar	1000 l/min	10 <input type="checkbox"/>	
			1500 l/min	15 <input type="checkbox"/>	
			2000 l/min	20 <input type="checkbox"/>	
			2500 l/min	25 <input type="checkbox"/>	
			3000 l/min	30 <input type="checkbox"/>	
			3500 l/min	35 <input type="checkbox"/>	
			4000 l/min	40 <input type="checkbox"/>	
			5000 l/min	50 <input type="checkbox"/>	
			6000 l/min	60 <input type="checkbox"/>	
			7000 l/min	70 <input type="checkbox"/>	
			8000 l/min	80 <input type="checkbox"/>	
				Altro Other	F <input type="checkbox"/>
OPZIONI OPTIONS	5	Verniciatura Painting	Verniciatura diversa da ciclo SA standard Painting system different for SA standard	C <input type="checkbox"/>	Specificare in Note il ciclo di verniciatura richiesto. Specify in Notes the painting procedure required.

NOTE
NOTES

CLIENTE / CLIENT:	PROGETTO / PROJECT:	DOC. No.:	REV.:
EMESSO / ISSUED:	CONTROLLATO / CHECKED:	APPROVATO / APPROVED:	
DATA / DATE:	DATA / DATE:	DATA / DATE:	

LI-10	Diagrammi Prestazioni Performance Diagrams	LI-15
	<p>Pressione (bar) / Portata (l/min) Pressure (bar) / Flow Rate (lpm)</p>	
	<p>Pressione (bar) / Forza di Reazione (kg) Pressure (bar) / Reaction Force (kg)</p>	
	<p>Pressione (bar) / Gittata (m), angolo 30° Pressure (bar) / Throw (m), angle 30°</p>	
	<p>Traiettorie (m), angoli 30° e 75° @ 7 bar Trajectories (m), angles 30° and 75° @ 7 bar</p>	

LI-20	Diagrammi Prestazioni Performance Diagrams	LI-25
	<p>Pressione (bar) / Portata (l/min) Pressure (bar) / Flow Rate (lpm)</p>	
	<p>Pressione (bar) / Forza di Reazione (kg) Pressure (bar) / Reaction Force (kg)</p>	
	<p>Pressione (bar) / Gittata (m), angolo 30° Pressure (bar) / Throw (m), angle 30°</p>	
	<p>Traiettorie (m), angoli 30° e 75° @ 7 bar Trajectories (m), angles 30° and 75° @ 7 bar</p>	

LI-30	Diagrammi Prestazioni Performance Diagrams	LI-35
	<p>Pressione (bar) / Portata (l/min) Pressure (bar) / Flow Rate (lpm)</p>	
	<p>Pressione (bar) / Forza di Reazione (kg) Pressure (bar) / Reaction Force (kg)</p>	
	<p>Pressione (bar) / Gittata (m), angolo 30° Pressure (bar) / Throw (m), angle 30°</p>	
	<p>Traiettorie (m), angoli 30° e 75° @ 7 bar Trajectories (m), angles 30° and 75° @ 7 bar</p>	

LI-40	Diagrammi Prestazioni Performance Diagrams	LI-50
	<p>Pressione (bar) / Portata (l/min) Pressure (bar) / Flow Rate (lpm)</p>	
	<p>Pressione (bar) / Forza di Reazione (kg) Pressure (bar) / Reaction Force (kg)</p>	
	<p>Pressione (bar) / Gittata (m), angolo 30° Pressure (bar) / Throw (m), angle 30°</p>	
	<p>Traiettorie (m), angoli 30° e 75° @ 7 bar Trajectories (m), angles 30° and 75° @ 7 bar</p>	

LI-60	Diagrammi Prestazioni Performance Diagrams	LI-70
	<p>Pressione (bar) / Portata (l/min) Pressure (bar) / Flow Rate (lpm)</p>	
	<p>Pressione (bar) / Forza di Reazione (kg) Pressure (bar) / Reaction Force (kg)</p>	
	<p>Pressione (bar) / Gittata (m), angolo 30° Pressure (bar) / Throw (m), angle 30°</p>	
	<p>Traiettorie (m), angoli 30° e 75° @ 7 bar Trajectories (m), angles 30° and 75° @ 7 bar</p>	

LI-80	Diagrammi Prestazioni Performance Diagrams	-
	<p>Pressione (bar) / Portata (l/min) Pressure (bar) / Flow Rate (lpm)</p>	-
	<p>Pressione (bar) / Forza di Reazione (kg) Pressure (bar) / Reaction Force (kg)</p>	-
	<p>Pressione (bar) / Gittata (m), angolo 30° Pressure (bar) / Throw (m), angle 30°</p>	-
	<p>Traiettorie (m), angoli 30° e 75° @ 7 bar Trajectories (m), angles 30° and 75° @ 7 bar</p>	-

VALVOLA A SFERA 3 VIE – VS3V
3 WAYS BALL VALVE – VS3V



Descrizione



La valvola a 3 vie VS3V è un dispositivo direzionale che viene montato sui monitori antincendio per selezionare tra due erogatori differenti ad acqua o a schiuma. La VS3V è costruita in Bronzo con una sfera interna in Derlin che la rende idonea per applicazioni con acqua industriale o marina. La sua forma geometrica compatta e la leva ergonomica la rendono estremamente semplice da usare. Il modello VS3V è disponibile per installazione su monitori da 3", 4" e 6".

Description



The 3 ways valve VS3V is a directional device that is installed on firefighting monitors to select among two different outlet projecting water or foam. The VS3V is manufactured in bronze with an internal sphere in Derlin and it is suitable for industrial and marine sea water. The specific compact geometry and the ergonomic lever make it very easy to operate. Model VS3V is available for installation on 3", 4" and 6" monitors.

Caratteristiche tecniche

- Corpo valvola in bronzo EN 1982 – CC491K
- Corpo sfera in Delrin
- Gomito a raggio corto a 90° in acciaio inox AISI 316
- Albero in acciaio inox AISI 316
- Leva in acciaio inox AISI 316
- Flangia quadra in acciaio inox AISI 316
- Seggi di tenuta in PTFE
- O-ring in EPDM
- Attacco mediante:
 - FQ 125
 - FQ 150
 - 6" ANSI 150
- Esecuzione idonea ad installazione esterna in ambiente marino e funzionamento con acqua mare
- Pressione massima di esercizio 16 bar
- Pressione di progetto 16 bar
- Pressione di collaudo 24 bar

Ciclo verniciatura standard SA:

- Pulizia manuale con solvente
- Primer epossidico 60 µm
- Intermedio poliuretano 30 µm
- Finitura poliuretano 30 µm
- Spessore totale film secco 120 µm +/-10%
- Colore rosso RAL 3000

Technical characteristics

- Body valve in bronze EN 1982 – CC491K
- Body ball in Delrin
- Short radius elbow 90° in stainless steel AISI 316
- Steam in stainless steel AISI 316
- Lever in stainless steel AISI 316
- Square flange in stainless steel AISI 316
- Sealing seats in PTFE
- O-ring in EPDM
- Connection:
 - SF 125
 - SF 150
 - 6" ANSI 150
- Suitable execution for external installation in marine environment and operation with sea water
- Max working pressure 16 bar
- Design pressure 16 bar
- Test pressure 24 bar

Painting system standard SA:

- Manual cleaning solvent
- Epoxy primer 60 µm
- Polyurethane intermediate 30 µm
- Polyurethane finish 30 µm
- Total thickness 120 µm dry film +/-10%
- Colour red RAL 3000

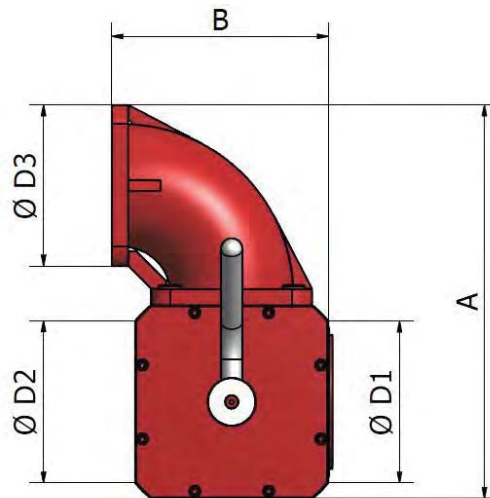

Ø D1	Ø D2	Ø D3	A mm	B mm	Peso Weight (kg)
FQ125 SF125	FQ150 SF150	FQ150 SF150	367	222	26.8
FQ150 SF150	FQ150 SF150	FQ150 SF150	367	202	24.6
6" ANSI 150	FQ150 SF150	FQ150 SF150	367	362	31.3

Opzioni

- Ciclo di verniciatura diverso dallo Standard SA
- Per ulteriori opzioni o versioni speciali contattare SA Fire Protection

Optional

- Painting system different from Standard SA
- For additional options or special versions contact SA Fire Protection

Accessori
Accessories

Pos.	Modello Model	Descrizione / Description	Foglio Dati Data Sheet	Pos.	Modello Model	Descrizione / Description	Foglio Dati Data Sheet
1	LI	Lancia Idrica Water Branchpipe	B 30 40 10 10	4	LSA	Lancia Schiuma Auto-aspirante Self-inducing foam branchpip 1000 ÷ 8000 l/min	B 30 30 20 10
2	LIB	Lancia Idrica e bocchello Nozzle and Water Branchpipe	B 30 40 10 10				
3	LS	Lancia Schiuma Foam Branchpipe 1000 ÷ 8000 l/min	B 30 30 10 10				

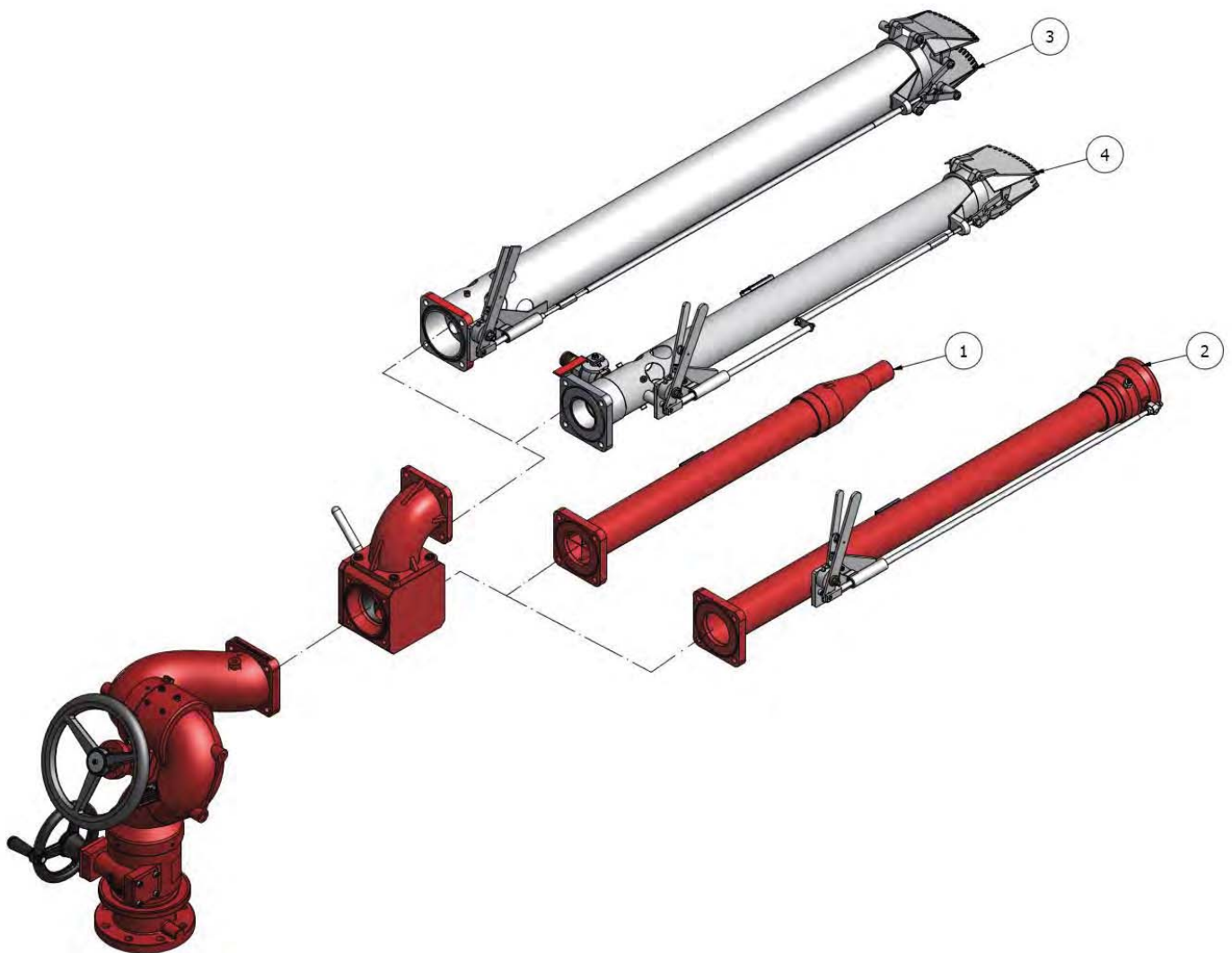

Dräger Nederland B.V.

Marine & Offshore
Beurtschipperstraat 1
3194 DK Hoogvliet
The Netherlands
Tel: +31 (0)10 295 2740
sales-mo.sd.nl@draeger.com

Service Center
Koperslagersweg 14F
1786 RA Den Helder
The Netherlands
Tel: +31 (0)223 787 007
denhelder-mo.sd.nl@draeger.com



www.draeger-mo.com